

# SPECIFICATION GUIDE

FOR ALL YOUR VENTILATION  
REQUIREMENTS



**Improving Indoor Air Quality**

SYSTEM VENTILATION · FANS · DUCTING

# ▶ CONTENTS

## MECHANICAL VENTILATION



### Mechanical Ventilation with Heat Recovery (MVHR)

Helps to create a healthy and clean indoor air environment whilst reducing household energy consumption.

HRXE-HERA®-B	12
HRXE-AURA®-B	15
HRXE-ZEUS®	18
HRX-aQ®	21
NOX-FILT™	25

### Mechanical Extract Ventilation (MEV)

Continuous, effective and efficient means of maintaining the indoor air quality.

CMX-MULTI™	27
CMX-S™	31
DMEV NICO	34

## INTERMITTENT EXTRACT FANS



### In-Line Fans

For short duct runs and shower applications. Loft mounted.

DBF100 100mm (4") Intermittent Axial	38
DKF150 150mm (6") Intermittent Axial	39
DVF 100mm DVF Axial Kit	40
DVF 150mm (6") High Perf, Vitalis	41

### Centrifugal Fans

For long duct runs. Wall/window mounted options.

Curzon 100mm (4")	42
Mayfair 100mm (4") Plug-In	43

## D SERIES



### D Series

Wide range of multipurpose wall, window, ceiling and roof extract fans with optional integrated and remote controls.

D Series Introduction	44
-----------------------	----

## DUCT SYSTEMS



### Green Line Duct Bends

Engineered to significantly reduce duct resistance, lower system noise and overall energy usage.

Green Line Duct Bends 63



### Rectangular

- 110x54mm
- 204x60mm
- 220x90mm

Duct 64



### Round

- Ø100mm
- Ø125mm
- Ø150mm

Duct 71



### Adapters

Transformation pieces from circular to flat duct.

In-Line Adapters 77  
Plenums 82  
Domus Radial 87



### Duct Solutions

Engineered to significantly reduce duct resistance, lower system noise and overall energy usage.

Attenuation 93  
Thermal Duct Insulation 96  
Domus Adapt 99



### Flexible Ducting

Flexible Ducting 125  
Ducting Accessories 132

## FIRE SOLUTIONS



### Fire Solutions

Fire Sleeves 104  
Solis AirBrick 110

## GRILLES AND EXTERNAL GRILLES



### Grilles and External Grilles

Grilles and External Grilles 106

The information contained in this publication is correct at the time of print and is subject to change. Please visit our website for the latest information: [www.domusventilation.co.uk](http://www.domusventilation.co.uk)

# ▶ HERO PRODUCTS

Since our inception, Domus Ventilation has aimed to be the number one supplier of ventilation products in the UK market place.

We are constantly innovating and improving to reaffirm our position as market leader. We have an active portfolio of new and improved product introductions. The most recent of these introductions is the new HRXE-ZEUS from our MVHR range.

These new additions complement our existing award winning product ranges NOX-FILT, the CMX- Multi plus our highly innovative Green Line Bend.

Product and service quality is of vital importance to us and we strive to deliver higher than expected levels based on customer feedback and new trends in the sector. If you have any questions or comments please get in touch with us on 03443 715 523.



# ▶ INTRODUCTION

Domus Ventilation is a manufacturer of market-leading ventilation systems that save energy and improve indoor air quality.



Formerly Polypipe Ventilation, the company has been reborn as Domus Ventilation, with new management and customer service teams, an expanded sales network and state-of-the-art production facilities in South Wales.

Domus Ventilation will continue to offer the multi award-winning Domus Ducting, that has been a UK market leader for over 50 years, as well as energy-efficient ventilation and indoor air quality systems.

Under the new name, and with an enhanced customer service team and increased sales force, Domus Ventilation is primed for growth and aims to be the number one supplier of ventilation products and accessories.

As a leading manufacturer of energy-saving ventilation systems, we offer high quality solutions for domestic and light commercial applications.

## ▶ Technical Support

Understanding your ventilation requirements is integral to ensuring that we tailor our solutions to meet your needs.

## ▶ Product Specification

Having established technical requirements, you will be supported each step of the way from order placement through to time planning.

## ▶ Stockists

Two significant manufacturing facilities, that help guarantee quick availability through a loyal nationwide network of Merchant and Electrical Wholesaler stockists.

## ▶ Delivery

Our national network of stockists offer a dedicated and managed logistics fleet, who are dedicated to providing efficient, quick and reliable delivery.

## ▶ Customer Services

We believe at Domus Ventilation we have the best people within the industry, working together to support all our customers, providing you with expert advice and guidance.



# ▶ BEST PRACTICE GUIDE

The following is offered as Best Practice guidance only, with information taken from statutory bodies including 'Approved Document F – Ventilation' (2021 edition incorporating 2010 and 2013 amendments).

All Domus Ventilation products comply with the latest regulatory governance, with supporting literature such as Installation & Maintenance manuals.

## Duct arrangement

External vents should be separated by a minimum of 300mm horizontally, if placed on the same façade.



### Why metal external AirBricks?

This has been brought in owing to legislation changes, Part B fire regulations have changed and now confirm that no combustible material i.e. PVC is to be installed in a cavity within or on the external surface of an external wall above 11m in Scotland and above 18m in England and Wales, therefore, giving us no option but to design and manufacture a metal version.

## Fixing and supporting ducts

Duct clips or support banding should be positioned at equal distances and no more than 750mm apart. Ducting should not be positioned in direct contact with other surfaces, such as plasterboard ceilings, to prevent noise transfer into the dwelling.

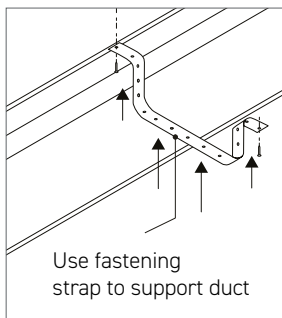

## Joining of ducts

We recommend that all ducts be connected and sealed using a non-hardening sealant to minimise air leakage. Consideration should be made to ducts installed in non-accessible areas, such as a ceiling void, to have a permanent fixing in place to supplement the sealing, preventing dislodging or movement during or after installation. The use of duct tape is permitted but should not be used as the only method of providing an airtight seal.

## Sizing of ducts

All ducting should be sized in accordance with current building regulations. When using MEV and MVHR systems, the ducting selected should be suitable for use with the product types.

Domus Ventilation recommends that a minimum duct size of 204x60mm or 125mm to be used with MEV and MVHR systems, to maintain an even distribution of airflow and low duct velocity.

Domus semi-rigid radial ducting systems may also be used, contact Domus Ventilation for further information.

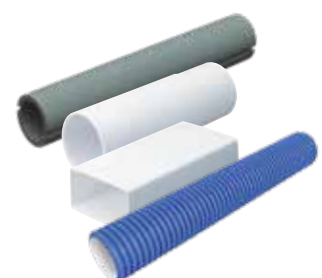

## Installation best practice

### Installation and positioning of air valves and external grilles:

- ▶ The air valve shall be located on the opposite side of the room from internal opening doors, creating a cross flow of air
- ▶ Should not be located less than 200mm to walls when installed on a ceiling
- ▶ Should not be located less than 400mm from a ceiling when installed on a wall
- ▶ Kitchen extract grilles should be a minimum of 600mm away from the hob

Air Valves should be lockable to prevent tampering once the system has been installed and commissioned.

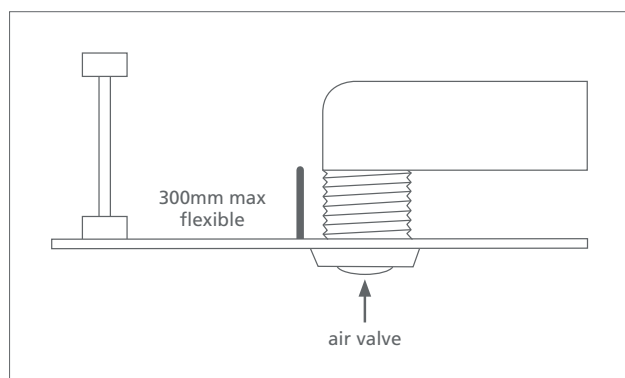

All grille locations should take into consideration room layouts and be positioned in such a way as to minimise down draughts over seating and sleeping areas.

Image	Part No	Diameter	Application		
			Wall	Sus Ceiling	Fire Rated
	136-04	100mm	✓		
	136-05	125mm			
	136-06	150mm			
	136-24	100mm		✓	
	136-25	125mm			
	136-26	150mm			
	136FR-24m	100mm			✓
	136FR-25m	125mm			
	136FR-26m	150mm			

## Extract ventilation rates

Extract ventilation rates			
Room	Intermittent Extract	Continuous Extract	
	Minimum rate	Minimum high rate	Minimum low rate
Kitchen	30l/s adjacent to hob, or 60l/s elsewhere	13l/s	Total extract rate should be at least the whole dwelling ventilation rate given in the table below.
Utility Room	30l/s	8l/s	
Bathroom	15l/s	8l/s	
Sanitary Accommodation	6l/s	6l/s	

Whole dwelling ventilation rates	
Number of bedrooms	Minimum ventilation rate by number of bedrooms (l/s)
1	19
2	25
3	31
4	37
5	43

### Note:

- If the dwelling only has one habitable room, a minimum ventilation rate of 13l/s should be used.
- For each additional bedroom, add 6l/s to the values shown in table above.

## Flexible ducting use with intermittent fans

For flexible duct connected to axial fans the length is limited to 1.5 metres; for centrifugal fans the length limit is 6 metres (for extract rates 6 to 30l/s) and 3 metres (for extract rates 31-60l/s).

The number of bends is limited to two for up to 30l/s, and reduces to one bend for higher extract rates.

Flexible duct should be pulled taut to ensure that the full internal diameter is obtained and flow resistance minimised.

This is considered to have been achieved if the duct is extended to 90% of its maximum length.

Flexible ducting generally requires more support than rigid ducting.

*It is suggested that flexible ducts should be supported at intervals not exceeding 600mm.*

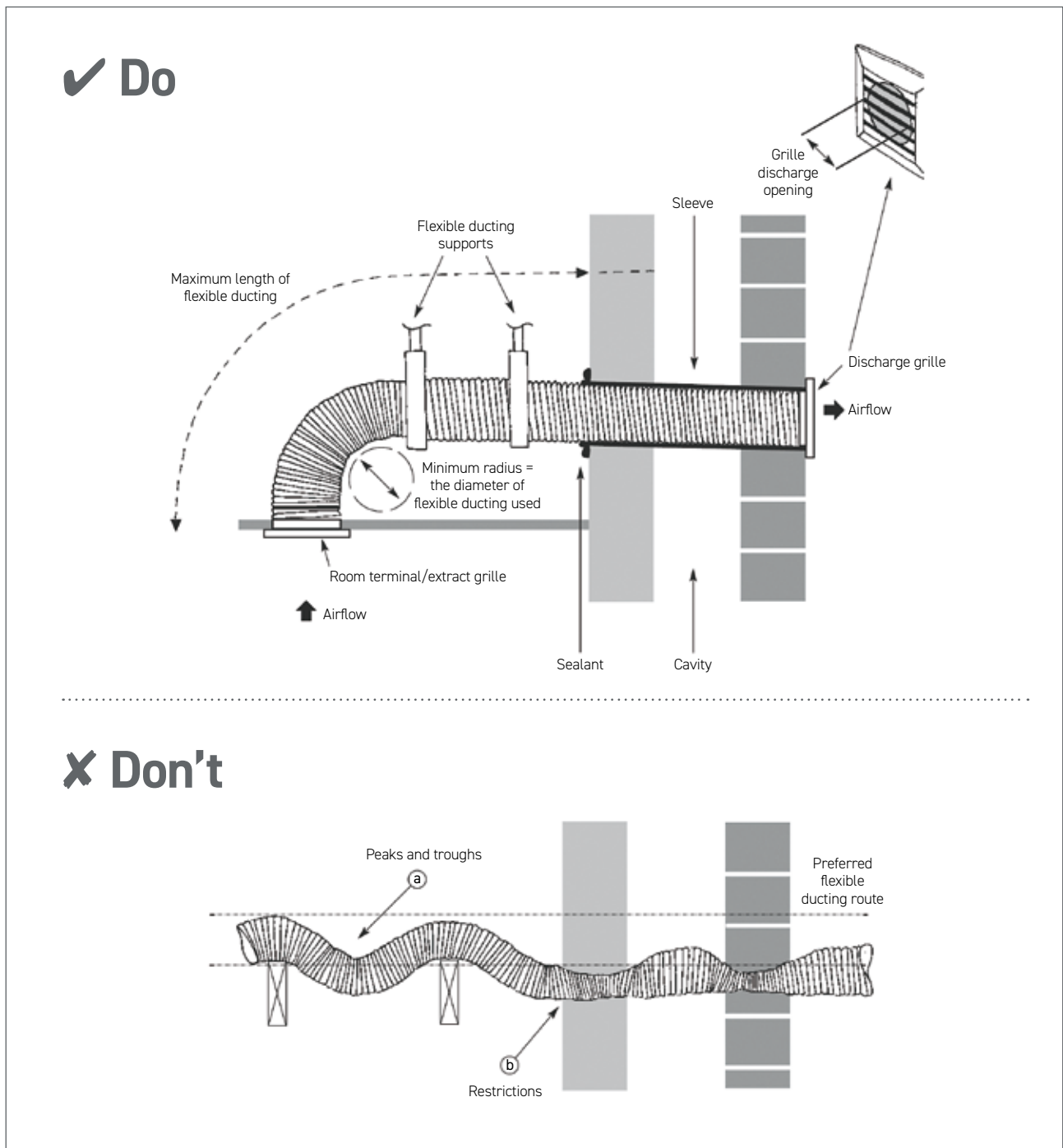

Reference: Approved Document F: Volume 1 Section 1.77



## Flexible ducting use with MVHR

Flexible duct should be:

- ▶ Not more than 300mm in length
- ▶ Located adjacent to fan units or air valves
- ▶ Not used to form bends

## Position of terminals

To prevent cross-contamination, supply ductwork terminals should normally be separated from exhaust ductwork terminals and other potential sources of pollution by a minimum of 1m measured on plan. Increased separation distances may be required between the supply and any:

- ▶ Soil and vent pipe terminal
- ▶ Boiler flue outlet
- ▶ Biomass or solid fuel chimney terminal

## Fire stopping

Proprietary fire components should be suitably tested and specified to take account of the test conditions. Appropriate standards include:

- ▶ BS 476 Fire tests on building materials and structures (relevant parts)
- ▶ BS EN 1365-2 Fire resistance tests for load bearing elements. Floors and roofs
- ▶ BS EN 1366-3 Fire resistance tests for service installations. Penetration seals

## Air valves and terminals

Air valves and terminals should be specified to be suitable for their location and function, and the velocity of the system. Airflow resistance should be calculated in accordance with BS EN 13141-2 Ventilation for buildings. Performance testing of components/products for residential ventilation. Exhaust and supply air terminal devices.

Adjustable air valves should be lockable, to prevent building users from altering them.

Terminals should be designed to prevent the entry of birds and animals.



## Control of condensation

Condensate can form where duct passes through spaces outside of the insulated parts of the home (such as a roof void) or when ductwork carrying cold air passes through spaces within the insulated parts of the home. Ductwork should be insulated to reduce the risk of condensation formation.

Where insulation is required to prevent condensation formation, it should be continuous and vapour resistant. This can be achieved by using either suitable pre-insulated ductwork or a proprietary insulation system with a thermal resistance equivalent to a minimum of 25mm of insulating material, with a thermal conductivity of 0.04W/(m.k).

Type of duct	Ductwork Continuously Insulated	
	Ductwork located inside the insulated part of the home	Ductwork located outside of the insulated part of the home
Intake	Yes	Yes
Exhaust	Yes	Yes
Service (supply and extract)	No	Yes

Pre-insulated to achieve a thermal performance equivalent to at least 25mm of insulating material with a thermal conductivity of 0.04W/(m.K)

Loft insulation used to achieve a total thermal performance equivalent to at least 150mm of insulating material with a thermal conductivity of 0.04W/(m.K)

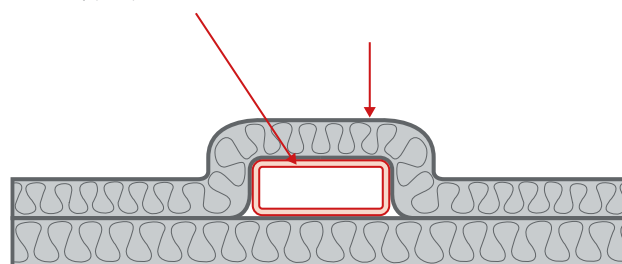

## Indoor Air Quality (IAQ)

Whilst there are currently no regulations concerning the quality of air inside a property, the subject of IAQ has been well publicised over the last few years owing to rising health concerns.

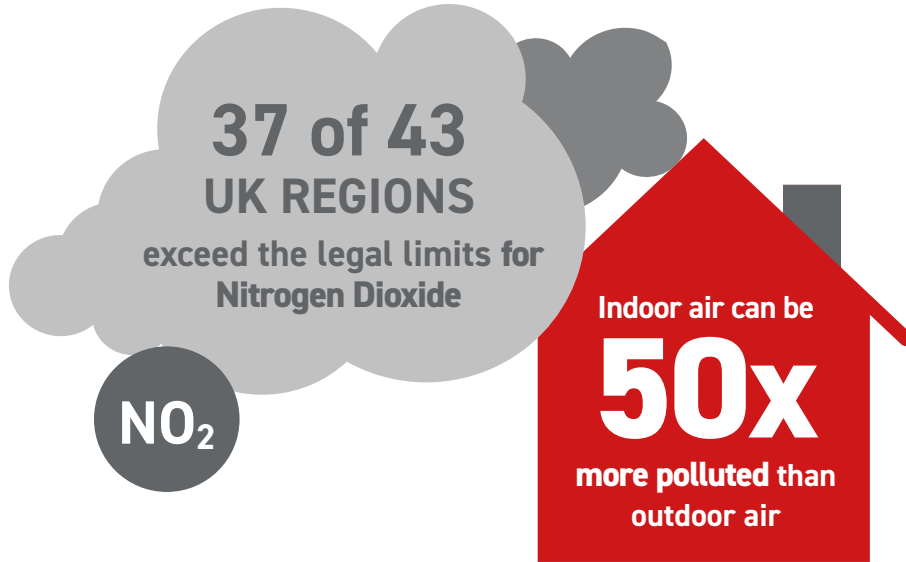

---

## Overheating in new-build properties

MEV and MVHR systems are increasingly being installed into new properties.

As a cost-effective means of lowering Dwelling Emission Rates to gain points towards achieving a higher SAP rating (as listed in the Product Characteristics Database), many developers and specifiers are seeing the benefit of adopting a whole house ventilation system, whilst also being able to improve the indoor environment for their clients.



# ▶ MECHANICAL VENTILATION PRODUCTS

When specifying or installing a ventilation system, consideration must be given to the total floor area, national Building Regulations, air permeability, occupancy levels, installation standards and ease of user operation and maintenance.

Select the most optimum system for your property and ensure your appliance's performance is maximised by installing the most suitable Domus Ventilation duct system.



## Mechanical Ventilation with Heat Recovery (MVHR)

Helps to create a healthy and clean indoor air environment whilst reducing household energy consumption.

Previously referred to as System 4 in Approved Document F of the Building Regulations, MVHR efficiently combines supply and extract ventilation into one centralised system.

As its primary function, waste, polluted and moist air is extracted from a dwelling's wet room via a duct system and is passed through a heat exchanger before being exhausted outside. Fresh incoming air is filtered and as an added benefit, pre-warmed via the heat exchanger and evenly distributed to the habitable rooms, thus reducing household energy consumption and the demand on existing heating systems.

The technology is most effective when installed in an air-tight dwelling as the effect is not compromised by external leakage.



## Mechanical Extract Ventilation (MEV)

A continuous, effective and efficient means of maintaining the indoor air quality that you breathe and live in.

Previously referred to as System 3 in Approved Document F of the Building Regulations, an MEV system consists of a centralised ventilation unit that continuously extracts waste, polluted and moist air from wet rooms and can be discreetly positioned in either a cupboard, utility room, ceiling or loft space.

An MEV system can be ducted throughout the dwelling and operated by the homeowner through a range of control options. Typically dual speed, MEV systems provide both low speed continuous trickle ventilation and high speed boost flow when required. Replacement fresh air is drawn into the dwelling through background ventilators i.e. air inlets, located in the living areas.



## Decentralised Mechanical Extract Ventilation (dMEV)

The highly efficient dMEV range offers continuous low level ventilation – to a single wet room, coupled with virtually silent operation.

Previously referred to as System 3 in Approved Document F of the Building Regulations, decentralised Mechanical Extract Ventilation (dMEV) systems incorporate continuously running extract fans, designed to remove waste and moist air from a single wet room.

dMEV fans continuously extract the waste air at both low trickle or boost speeds, as determined by the homeowner through a range of control options. Replacement fresh air is then drawn into the dwelling via background ventilators located in the habitable rooms.

**SYSTEM 4**  
**MECHANICAL VENTILATION WITH HEAT RECOVERY (MVHR)**

# HRXE-HERA-B

All HRXE-HERA-B models have been designed with 100% automatic bypass, listed on the SAP Product Characteristics Database (PCDB).

The HRXE-HERA-B range operate by continuously extracting moisture-laden air from 'wet' rooms within the property whilst simultaneously drawing in fresh, filtered supply air from outside.

The heat from the extracted stale air is recovered via a heat exchanger inside the heat recovery unit which becomes tempered and filtered, before supplied in to the habitable rooms, creating comfortable and well ventilated homes.

## Key features

- ▶ The heat exchanger block within these units can recover up to 95% of the normally wasted heat. The two independent fans have full-speed control for background and boost ventilation rates.
- ▶ The HRXE-HERA-B range has a Summer bypass function. In warmer months this function automatically activates to ensure the property is being well-ventilated and comfort levels are maintained in the home by continuously drawing in fresh filtered air into the habitable rooms.
- ▶ Due to its intelligent design, there will be no reduction in airflow when operating in bypass mode resulting in enhanced performance.
- ▶ Designed to provide optimised balanced (supply and extract) mechanical ventilation with heat recovery and both listed on the PCDB.
- ▶ Weight: 20kg.

## Accessories

Code	Description
HRXE-HERA-AV	Anti-Vibration tray suitable for all HRXE-HERA models
297	Condensate Drain Kit for all HRXE-HERA models
SPR428	Replacement filters (pair)



Code	Description
HRXE-HERA-B	Standard unit with 100% bypass
HRXE-HERA-OP-B	Opposite handed unit with 100% bypass
HRXE-HERA-H-B	Standard unit with 100% bypass inc. humidistat
HRXE-HERA-OPH-B	Opposite handed unit with 100% bypass inc. humidistat

## Dimensions (mm)



Front View

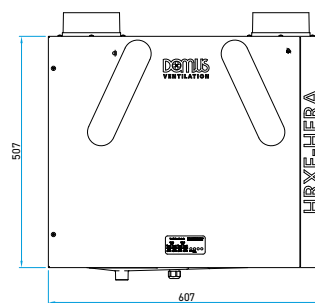

Side View

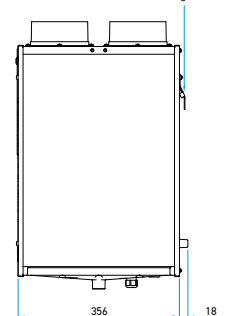

Top View

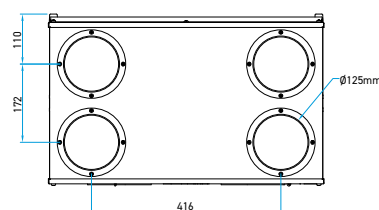

## Performance

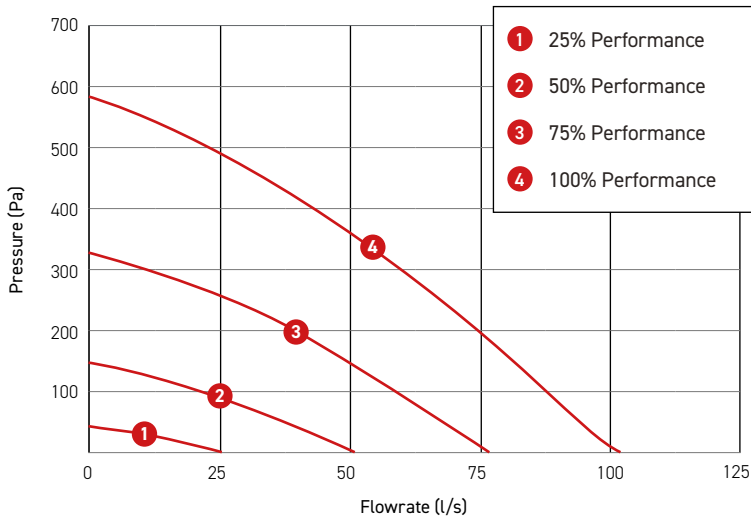

Standard Handing



Plan View

## Installation



**Supports kitchen and up to seven wet rooms.**

**Floor area 250m<sup>2</sup>.**

Building Regulations Compliant 

ErP Directive Compliant 

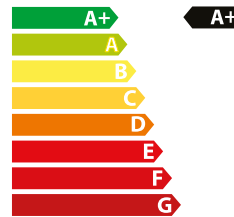

Opposite Handing



Plan View

### HRXE-HERA-B PRODUCT CHARACTERISTICS DATABASE (SAP 2012 TEST RESULTS)

Application	Specific Fan Power (W/l/s)	Heat Exchange Efficiency	Energy Saving Trust Best Practice Compliant
Kitchen + 1 Wet Room	0.55	90%	Yes
Kitchen + 2 Wet Room	0.65	89%	Yes
Kitchen + 3 Wet Room	0.80	87%	Yes
Kitchen + 4 Wet Room	1.01	86%	Yes
Kitchen + 5 Wet Room	1.20	86%	Yes

### ACOUSTIC PERFORMANCE

Curve	Max power consumption (Watts)		Sound Power Levels dB re 1pW (Frequency Hz)								dBA @3m
			63	125	250	500	1k	2k	4k	8k	
1	6	Open inlet	38	36	41	37	29	21	<16	<16	18
		Open outlet	38	43	47	49	45	39	26	<16	
		Breakout	37	39	39	37	28	20	<16	<16	
2	20	Open inlet	40	39	50	44	37	31	<16	<16	27
		Open outlet	48	54	55	58	53	50	39	27	
		Breakout	43	48	46	46	37	32	17	<16	
3	66	Open inlet	42	44	57	51	44	40	26	17	34
		Open outlet	54	61	62	65	61	59	49	39	
		Breakout	51	56	52	53	44	40	27	16	
4	163	Open inlet	45	49	59	55	48	44	31	24	38
		Open outlet	55	54	66	69	66	63	54	45	
		Breakout	58	48	56	57	48	44	31	22	

Note: dBA is hemi-spherical at 3 metres. For spherical deduct 3 dBA.

Please note that the noise data stated on this data sheet for the unit and/or silencer is tested in accordance with UK, European and International industry laboratory standards. However onsite conditions may vary and we would recommend that this information is verified by an acoustic specialist in order to ensure its suitability for the intended application.

5 year warranty\*. \*First year parts and labour

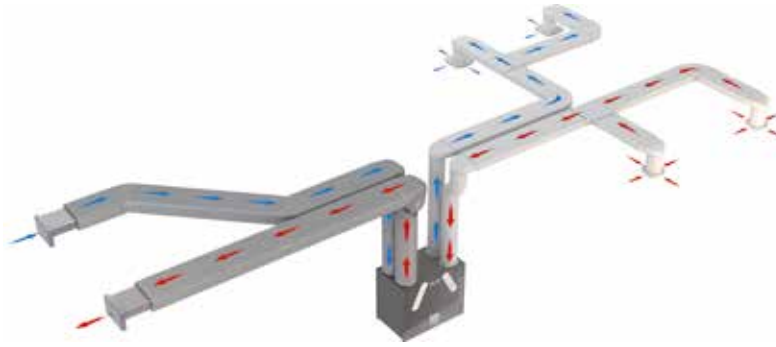
**System illustration**

Standard handing installation

## Consultant specification for HRXE-HERA-B

### Specification

The unit is fully insulated, providing excellent thermal and acoustic characteristics and is complete with a multiplate, counter-flow, high-efficiency heat exchanger block, with a thermal efficiency of up to 95%. The heat exchanger is protected by G3 grade filters on fresh air inlet and system extract. The heat exchanger and filters are accessible via the front access panel, enabling quick and easy maintenance.

The unit has low energy, high-efficiency EC fan/motor assemblies with sealed for life bearings, the impellers are backward curved centrifugal type. The motors are suitable for an ambient temperature of 40°C.

The unit is supplied complete with an insulated condensate drip tray and 21.5mm drain connection.

The unit is suitable for 125mm circular ducting. Note: The unit is also available in opposite handed format, refer to spigot configuration for set up.

The breakout noise level and power requirements as detailed by the unit manufacturer and in accordance with the ventilation equipment schedule.

Units will be HRXE as manufactured by Domus Ventilation and will be listed on the SAP PCDB.

HRXE-HERA-OP-B & HRXE-HERA-OPH-B are opposite handed assemblies compliant as per standard handed versions listed in SAP PCDB.

### Operation

The supply and extract system shall be positioned as indicated on the drawings and in accordance with the particular fan schedule in the specification.

The combined supply and extract with heat recovery unit shall supply filtered fresh air to each of the habitable rooms and moisture-laden air will be extracted from all wet areas, e.g. bathroom, en suite, w.c., kitchen, utility rooms etc. The supply air will be pre-heated by the warm extract air via the integrated counter-flow heat exchanger element. The extracted air will also be filtered before it reaches the heat exchanger block.

The ventilation unit shall vary its speed and, therefore, the ventilation rate, as it receives signals from one of the following:

- Switched live signal from light/remote switches
- When signals are received, the fan shall alter its speed to adjustable, normal and boost rates

The unit has the facility to commission the supply and extract fans independently on minimum speed (continuous background ventilation) and boost speed via inbuilt minimum and maximum speed adjustment. The fans have infinitely variable speed control.

### Integral Automatic HX Bypass with no reduction in airflow

The bypass damper opens automatically via a wax actuator, allowing the air to bypass the heat exchanger to deliver fresh filtered air during the warmer months.

The automatic bypass diverts 100% airflow around the heat exchanger with no reduction in airflow as independently tested by the BRE.

### Integral Humidity Sensor

The integral humidity sensor incorporated within the extract fan chamber will automatically boost both the extract and supply fan to the commissioned boost speed, when the humidity level exceeds that set by the front panel mounted adjustment potentiometer.

### Control Options

All versions shall have the following functions integrally mounted within the fan unit on a purpose made PCB, all such components are pre-wired and factory fitted by the manufacturer:

- ▶ Independent control of background supply and extract flow rates
- ▶ Independent control of boost speed supply and extract flow rates
- ▶ Integral heat exchanger frost protection
- ▶ Fan failure indication
- ▶ Integral S/L terminal for boost from remote switch, e.g. light switch
- ▶ Additional S/L terminal for 100% boost speed from remote switch, e.g. plate switch
- ▶ Discreet daily run monitor
- ▶ Indication and controls – the unit shall have clear LED visual indication for maintenance, servicing and operation mode, i.e. HX bypass, frost protection
- ▶ The unit comes with a 5 year warranty which starts from the day of delivery, and includes parts and labour for the first year and parts only for the remaining four years

## SYSTEM 4 MECHANICAL VENTILATION WITH HEAT RECOVERY (MVHR)

# HRXE-AURA-B

All HRXE-AURA-B models have been designed with 100% automatic bypass, listed on the SAP Product Characteristics Database (PCDB).

The HRXE-AURA-B range operate by continuously extracting moisture-laden air from 'wet' rooms within the property whilst simultaneously drawing in fresh, filtered supply air from outside.

The heat from the extracted stale air is recovered via a heat exchanger inside the heat recovery unit which becomes tempered and filtered, before supplied in to the habitable rooms, creating comfortable and well ventilated homes.

### Key features

- ▶ The heat exchanger block within these units can recover up to 95% of the normally wasted heat. The two independent fans have full-speed control for background and boost ventilation rates.
- ▶ The HRXE-AURA-B range has a Summer bypass function. In warmer months this function automatically activates to ensure the property is being well-ventilated and comfort levels are maintained in the home by continuously drawing in fresh filtered air into the habitable rooms.
- ▶ Due to its intelligent design, there will be no reduction in airflow when operating in bypass mode resulting in enhanced performance.
- ▶ Designed to provide optimised balanced (supply and extract) mechanical ventilation with heat recovery and both listed on the PCDB.
- ▶ Weight: 24kg.

### Accessories

Code	Description
HRXE-AURA-AV	Anti-Vibration tray suitable for all HRXE-AURA models
297	Condensate Drain Kit for all HRXE-AURA models
SPR447	Replacement filters (pair)



Code	Description
HRXE-AURA-B	Standard unit with 100% bypass
HRXE-AURA-H-B	Standard unit with 100% bypass and integral humidistat
HRXE-AURA-OP-B	Opposite handed unit with 100% bypass
HRXE-AURA-OPH-B	Opposite handed unit with 100% bypass and integral humidistat

### Dimensions (mm)



Front View

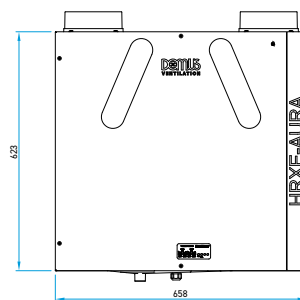

Side View

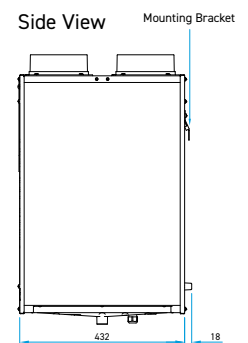

Top View

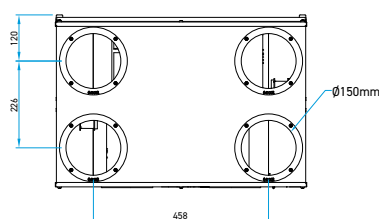

## Performance

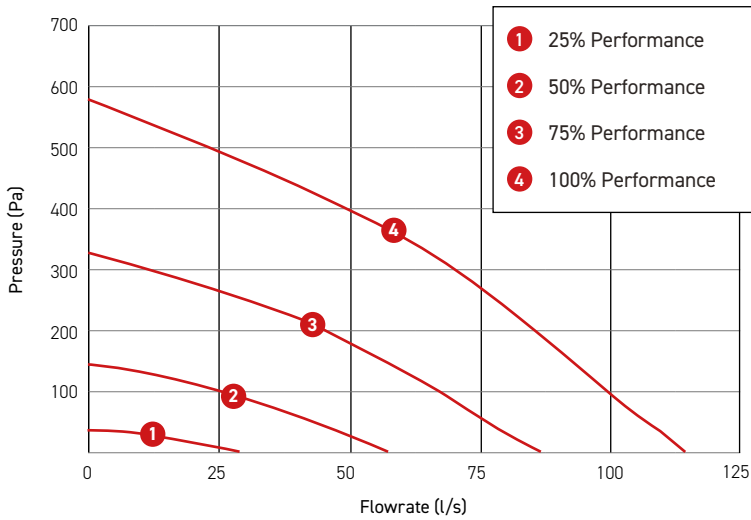

Standard Handing



Plan View

## Installation



**Supports kitchen and up to 7 wetrooms. Floor Area 217m<sup>2</sup>. A whole house System.**

- Building Regulations Compliant
✓
- ErP Directive Compliant
✓

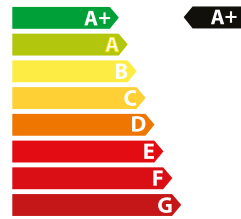

Opposite Handing

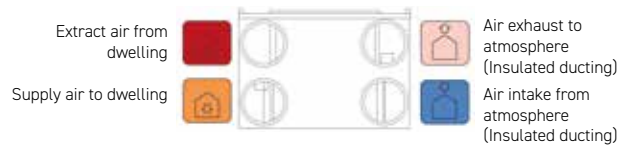

Plan View

### HRXE-AURA-B PRODUCT CHARACTERISTICS DATABASE (SAP 2012 TEST RESULTS)

Application	Specific Fan Power (W/l/s)	Heat Exchange Efficiency	Energy Saving Trust Best Practice Compliant
Kitchen + 1 Wet Room	0.56	90%	Yes
Kitchen + 2 Wet Room	0.58	90%	Yes
Kitchen + 3 Wet Room	0.65	89%	Yes
Kitchen + 4 Wet Room	0.79	88%	Yes
Kitchen + 5 Wet Room	0.95	88%	Yes
Kitchen + 6 Wet Room	1.15	87%	Yes
Kitchen + 7 Wet Room	1.26	87%	Yes

### ACOUSTIC PERFORMANCE

Curve	Max power consumption (Watts)		Sound Power Levels dB re 1pW (Frequency Hz)								dBa @3m
			63	125	250	500	1k	2k	4k	8k	
1	6	Open inlet	36	35	40	36	30	21	<16	<16	20
		Open outlet	40	47	44	48	43	38	25	<16	
		Breakout	45	40	41	39	30	25	<16	<16	
2	20	Open inlet	39	45	49	43	38	31	17	<16	28
		Open outlet	46	54	52	55	51	48	37	25	
		Breakout	48	48	46	47	38	33	19	<16	
3	66	Open inlet	42	52	56	50	46	40	27	17	35
		Open outlet	52	60	59	63	59	58	49	39	
		Breakout	52	54	52	53	45	42	27	<16	
4	163	Open inlet	44	54	59	54	49	44	32	23	38
		Open outlet	55	63	63	66	64	63	55	46	
		Breakout	57	57	56	57	49	47	33	19	

The maximum power consumption shown above (Watts) is consumed on units running continuously, not taking into account any heat recovery saving and based on SAP Product Characteristic Database (PCDB) testing. The breakout case-radiated dBA values are given for Hemispherical free field radiation at 3m - to obtain the Spherical radiated data, subtract 3 dBA.

Please note: Sound data is provided at a particular duty point for 25%, 50%, 75% and 100%. For accurate sound data at a specific speed duty, please call the office on 03443 715 523.

5 year warranty\*. \*First year parts and labour

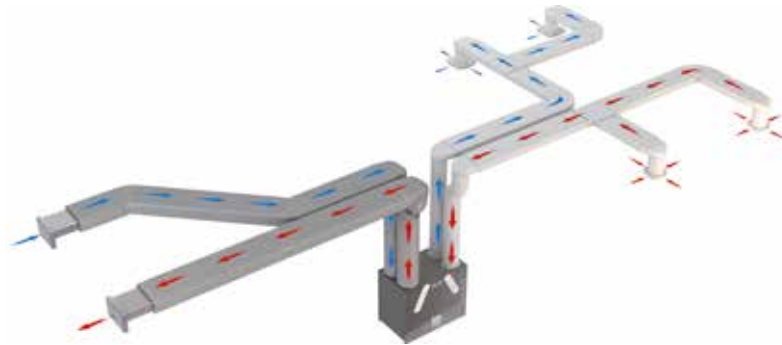

**System illustration**

Standard handing installation

## Consultant specification for HRXE-AURA-B

### Specification

The unit is fully insulated providing excellent thermal and acoustic characteristics and is complete with a multiplate, counter-flow, high-efficiency heat exchanger block, with a thermal efficiency of up to 95%. The heat exchanger is protected by G3 grade filters on fresh air inlet and system extract. The heat exchanger and filters shall be accessible via the front access panel, enabling quick and easy maintenance.

The unit has low energy, high-efficiency EC fan/motor assemblies with sealed-for-life bearings, the impellers are backward curved centrifugal type. The motors are suitable for an ambient temperature of 40°C.

The unit is supplied complete with an insulated condensate drip tray and 21.5mm drain connection.

The unit is suitable for 150mm circular ducting. Note: The unit is also available in opposite handed format, refer to spigot configuration for set up.

The breakout noise level and power requirements are as detailed by the unit manufacturer and in accordance with the ventilation equipment schedule.

Units will be HRXE as manufactured by Domus Ventilation and will be listed on the SAP PCDB.

HRXE-AURA-OP-B & HRXE-AURA-OPH-B are opposite handed assemblies compliant as per standard handed versions listed in SAP PCDB.

### Operation

The supply and extract system is positioned as indicated on the drawings and are in accordance with the particular fan schedule in the specification.

The combined supply and extract with heat recovery unit supplies filtered fresh air to each of the habitable rooms and moisture-laden air is extracted from all wet areas, e.g. bathroom, en suite, w.c, kitchen, utility rooms etc. The supply air will be pre-heated by the warm extract air via the integrated counter-flow heat exchanger element. The extracted air is also filtered before it reaches the heat exchanger block.

The ventilation unit varies its speed and therefore the ventilation rate, as it receives signals from one of the following:

- Switched live signal from light/remote switches
- When signals are received, the fan shall alter its speed to adjustable, normal and boost rates

The unit has the facility to commission the supply and extract fans independently on minimum speed (continuous background ventilation) and boost speed via inbuilt minimum and maximum speed adjustment. The fans have infinitely variable speed control.

### Integral Automatic HX Bypass with no reduction in airflow

The bypass damper opens automatically via a wax actuator, allowing the air to bypass the heat exchanger to deliver fresh filtered air during the warmer months.

The automatic bypass diverts 100% airflow around the heat exchanger with no reduction in airflow as independently tested by the BRE.

### Integral Humidity Sensor

The integral humidity sensor incorporated within the extract fan chamber will automatically boost both the extract and supply fan, to the commissioned boost speed, when the humidity level exceeds that set by the front panel mounted adjustment potentiometer.

### Control Options

All versions have the following functions integrally mounted within the fan unit on a purpose made PCB, all components are pre-wired and factory fitted by the manufacturer:

- ▶ Independent control of background supply and extract flow rates
- ▶ Independent control of boost speed supply and extract flow rates
- ▶ Integral heat exchanger frost protection
- ▶ Fan failure indication
- ▶ Integral S/L terminal for boost from remote switch, e.g. light switch
- ▶ Additional S/L terminal for 100% boost speed from remote switch, e.g. plate switch
- ▶ Discreet daily run monitor
- ▶ Indication and controls – the unit shall have clear LED visual indication for maintenance, servicing and operation mode, i.e. HX bypass, frost protection
- ▶ The unit comes with a 5 year warranty which starts from the day of delivery, and includes parts and labour for the first year and parts only for the remaining four years

**SYSTEM 4**  
**MECHANICAL VENTILATION WITH HEAT RECOVERY (MVHR)**

# HRXE-ZEUS®

All HRXE-ZEUS models have been designed with 100% automatic bypass, listed on the SAP Product Characteristics Database (PCDB).

The HRXE-ZEUS range operate by continuously extracting moisture-laden air from 'wet' rooms within the property whilst simultaneously drawing in fresh, filtered supply air from outside.

The heat from the extracted stale air is recovered via a heat exchanger inside the heat recovery unit which becomes tempered and filtered, before supplied into the habitable rooms, creating comfortable and well-ventilated homes.

## Key features

- ▶ The heat exchanger block within these units can recover up to 95% of the normally wasted heat. The two independent fans have full-speed control for background and boost ventilation rates.
- ▶ The HRXE-ZEUS range has a summer bypass function. In warmer months this function automatically activates to ensure the property is being well-ventilated and comfort levels are maintained in the home by continuously drawing in fresh filtered air into the habitable rooms.
- ▶ Due to its intelligent design, there will be no reduction in airflow when operating in bypass mode resulting in enhanced performance.
- ▶ Designed to provide optimized balanced (supply and extract) mechanical ventilation with heat recovery, listed on the PCDB.
- ▶ Weight: 45kg.

## Accessories

Code	Description
HRXE-ZEUS-AV	Anti-Vibration tray suitable for all HRXE-ZEUS models
297	Condensation Drain Kit for all HRXE-ZEUS models
SPR459	Replacement filters (Pair)



Code	Description
HRXE-ZEUS	Standard unit with 100% bypass
HRXE-ZEUS-H	Standard unit with 100% bypass and integral humidistat
HRXE-ZEUS-OP	Opposite handed unit with 100% bypass
HRXE-ZEUS-OPH	Opposite handed unit with 100% bypass and integral humidistat

## Dimensions (mm)



Front View

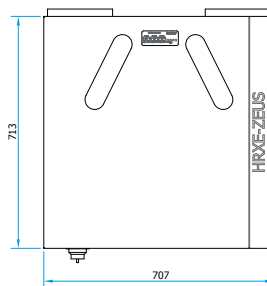

Side View

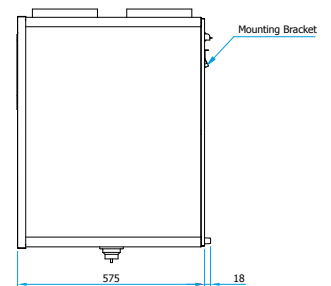

Top View

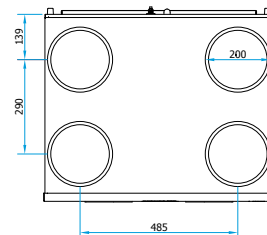

## Performance

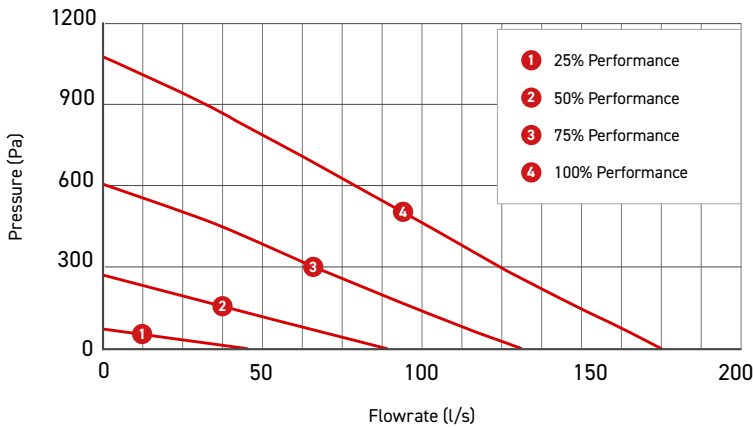

## Installation



**Supports kitchen and up to seven wet rooms.**

**Floor area 250m<sup>2</sup>.**

Building Regulations Compliant

✓

ErP Directive Compliant

✓

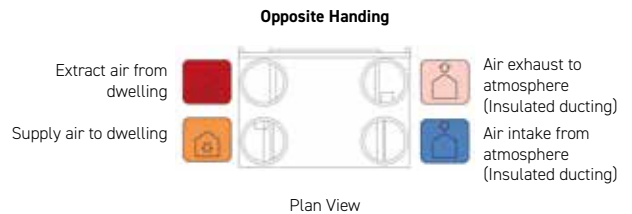
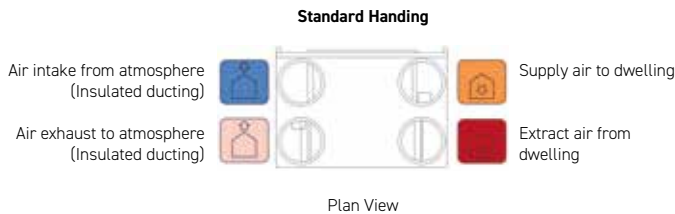

HRXE-ZEUS PRODUCT CHARACTERISTICS DATABASE (SAP 2012 TEST RESULTS)			
Application	Specific Fan Power (W/l/s)	Heat Exchange Efficiency	Energy Saving Trust Best Practice Compliant
Kitchen + 1 Wet Room	0.62	94%	Yes
Kitchen + 2 Wet Rooms	0.62	93%	Yes
Kitchen + 3 Wet Rooms	0.66	93%	Yes
Kitchen + 4 Wet Rooms	0.79	92%	Yes
Kitchen + 5 Wet Rooms	0.94	91%	Yes
Kitchen + 6 Wet Room	1.15	91%	Yes
Kitchen + 7 Wet Room	1.41	91%	Yes

ACOUSTIC PERFORMANCE											
Curve	Max power consumption (Watts)		Sound Power Levels dB re 1pW (Frequency Hz)								dBA @3m
			63	125	250	500	1k	2k	4k	8k	
1	5.3	Open inlet	41	42	29	31	27	17	<16	<16	17
		Open outlet	46	53	39	44	37	30	16	<16	
		Breakout	42	49	37	32	28	16	<16	<16	
2	42	Open inlet	42	44	36	36	31	24	<16	<16	22
		Open outlet	48	55	47	48	42	37	25	<16	
		Breakout	45	51	44	37	31	21	<16	<16	
3	142	Open inlet	45	49	48	45	39	35	22	<16	31
		Open outlet	53	60	60	57	51	50	41	34	
		Breakout	52	57	56	46	38	31	19	<16	
4	335	Open inlet	51	54	55	56	48	43	33	25	40
		Open outlet	59	64	64	70	60	58	52	47	
		Breakout	61	61	60	59	46	38	30	20	

The maximum power consumption shown above (Watts) is consumed on units running continuously, not taking into account any heat recovery saving and based on SAP Product Characteristic Database (PCDB) testing. The breakout case-radiated dBA values are given for Hemispherical free field radiation at 3m - to obtain the Spherical radiated data, subtract 3 dBA.

Please note: Sound data is provided at a particular duty point for 25%, 50%, 75% and 100%. For accurate sound data at a specific speed duty, please call the office on 03443 715 523.

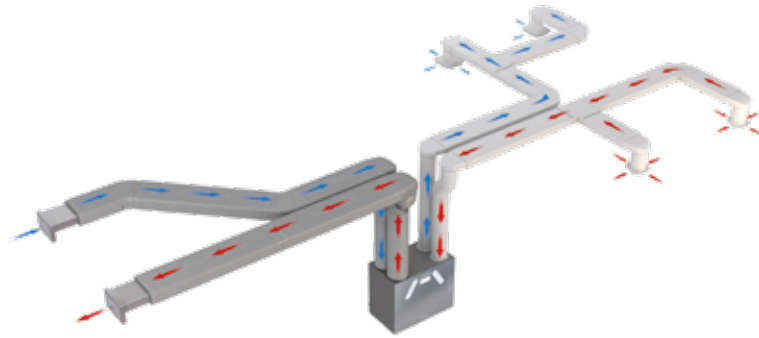
**System illustration**

Standard hanging installation

## Consultant specification for HRXE-ZEUS

### Specification

The unit is fully insulated, providing excellent thermal and acoustic characteristics and is complete with a multiplate, counter-flow, high-efficiency heat exchanger block, with a thermal efficiency of up to 95%. The heat exchanger is protected by G3 grade filters on fresh air inlet and system extract. The heat exchanger and filters are accessible via the front access panel, enabling quick and easy maintenance.

The unit has low energy, high-efficiency EC fan/motor assemblies with sealed for life bearings, the impellers are backward curved centrifugal type. The motors are suitable for an ambient temperature of 40°C.

The unit is supplied complete with an insulated condensate drip tray and 32mm drain connection.

The unit is suitable for 150mm circular ducting. Note: The unit is also available in opposite handed format, refer to spigot configuration for set up.

The breakout noise level and power requirements as detailed by the unit manufacturer and in accordance with the ventilation equipment schedule.

Units will be HRXE as manufactured by Domus Ventilation and will be listed on the SAP PCDB.

HRXE-ZEUS-OP & HRXE-ZEUS-OPH are opposite handed assemblies compliant as per standard handed versions listed in SAP PCDB.

### Operation

The supply and extract system shall be positioned as indicated on the drawings and in accordance with the particular fan schedule in the specification.

The combined supply and extract with heat recovery unit shall supply filtered fresh air to each of the habitable rooms and moisture-laden air will be extracted from all wet areas, e.g. bathroom, en suite, w.c., kitchen, utility rooms etc. The supply air will be pre-heated by the warm extract air via the integrated counter-flow heat exchanger element. The extracted air will also be filtered before it reaches the heat exchanger block.

The ventilation unit shall vary its speed and, therefore, the ventilation rate, as it receives signals from one of the following:

- Switched live signal from light/remote switches
- When signals are received, the fan shall alter its speed to adjustable, normal and boost rates

The unit has the facility to commission the supply and extract fans independently on minimum speed (continuous background ventilation) and boost speed via inbuilt minimum and maximum speed adjustment. The fans have infinitely variable speed control.

### Integral Automatic HX Bypass with no reduction in airflow

The bypass damper opens automatically via a wax actuator, allowing the air to bypass the heat exchanger to deliver fresh filtered air during the warmer months.

The automatic bypass diverts 100% airflow around the heat exchanger with no reduction in airflow as independently tested by the BRE.

### Integral Humidity Sensor

The integral humidity sensor incorporated within the extract fan chamber will automatically boost both the extract and supply fan to the commissioned boost speed, when the humidity level exceeds that set by the front panel mounted adjustment potentiometer.

### Control Options

All versions shall have the following functions integrally mounted within the fan unit on a purpose made PCB, all such components are pre-wired and factory fitted by the manufacturer:

- ▶ Independent control of background supply and extract flow rates
- ▶ Independent control of boost speed supply and extract flow rates
- ▶ Integral heat exchanger frost protection
- ▶ Fan failure indication
- ▶ Integral S/L terminal for boost from remote switch, e.g. light switch
- ▶ Additional S/L terminal for 100% boost speed from remote switch, e.g. plate switch
- ▶ Discreet daily run monitor
- ▶ Indication and controls – the unit shall have clear LED visual indication for maintenance, servicing and operation mode, i.e. HX bypass, frost protection
- ▶ The unit comes with a 5 year warranty which starts from the day of delivery, and includes parts and labour for the first year and parts only for the remaining four years
- ▶ There is AV ancillaries available for the whole MVHR range
- ▶ It is perfect for application where transfer of sound is a concern

**SYSTEM 4**  
**MECHANICAL VENTILATION WITH HEAT RECOVERY (MVHR)**

# HRX-aQ<sup>®</sup>

The most compact and intelligent MVHR ceiling unit on the market. HRX-aQ models enable contractors to deliver quick installation of a unique ventilation system; complete with Bluebrain Controller.

### Key features

- ▶ Specific Fan Power (SFP) down to 0.72(W/l/s).
- ▶ Bluebrain control optimises the unit's functionality and allows for quick and easy commissioning through simple speed adjustment buttons.
- ▶ High heat exchange efficiency up to 87%.
- ▶ Extremely quiet in operation, 24dB(A).
- ▶ Compact and lightweight – weighs 7.9kg and measures 199mm in depth.

### Installation

**Supports kitchen and up to two wet rooms**

**Floor area 80m<sup>2</sup>**

- Building Regulations Compliant
✓
- ErP Directive Compliant
✓

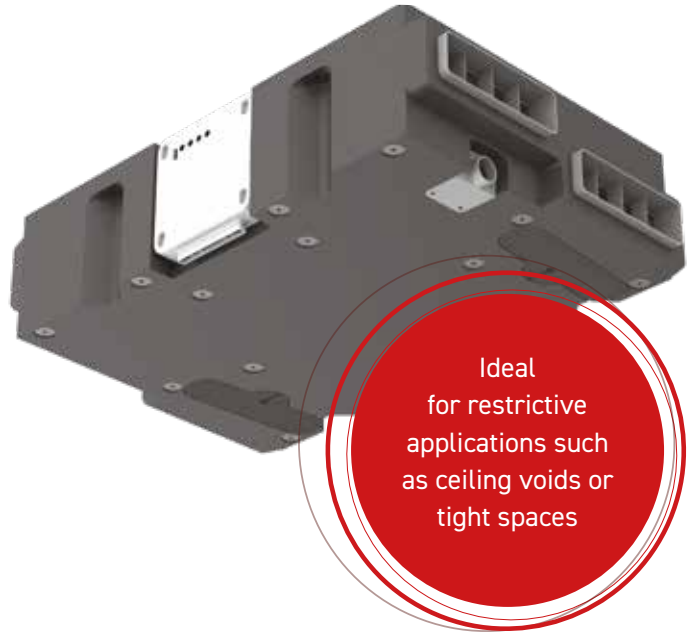
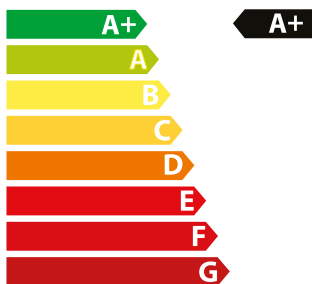

Code	Description
AQH200-B	Void Mounted MVHR unit bypass

### Dimensions (mm)

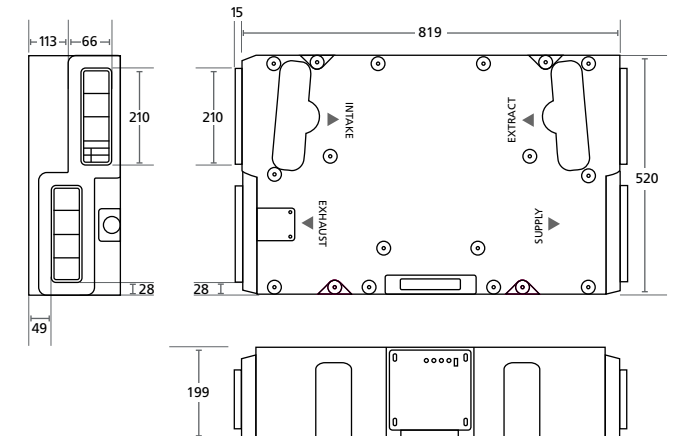

### Accessories

Code	Description
297	Condensate Drain (not included)
AQHC-CC8	8 metre data cable (not included)
SPR442	Replacement filters for AQH200-B

**Incorporates an advanced Bluebrain® control**

Ultimate, flexible and intelligent control  
Straightforward, accurate commissioning



**System illustration**

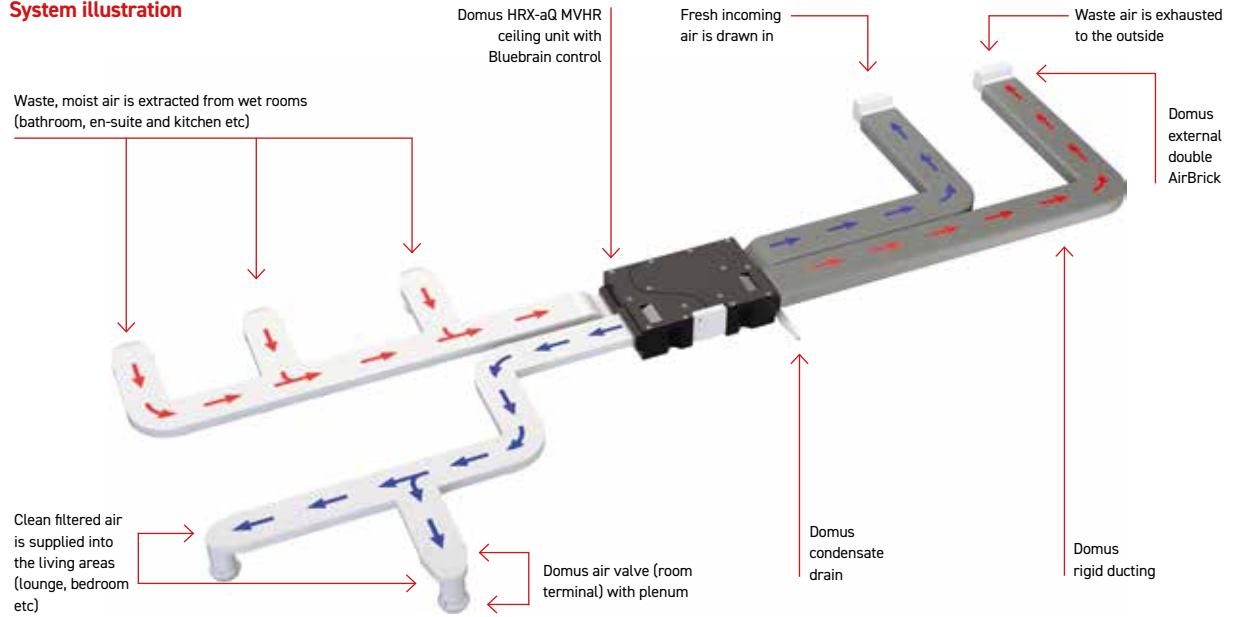

Offset duct makes fitting simple

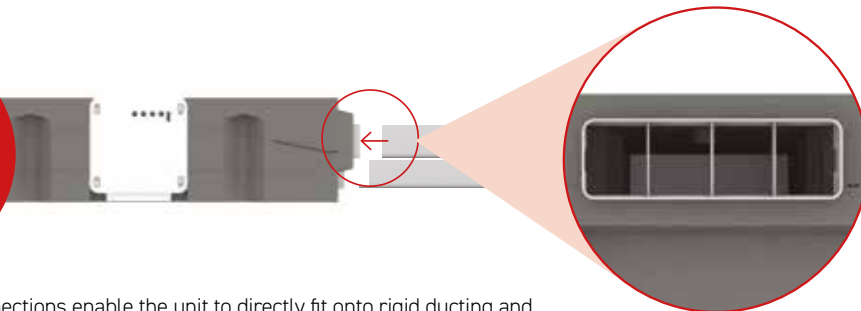

204x60mm socket connections enable the unit to directly fit onto rigid ducting and remove the need for additional adapters. For information on Domus rigid ducting, go to page 62. For Radial semi-rigid ducting, go to page 89.

# Sound performance

## AQH200-B

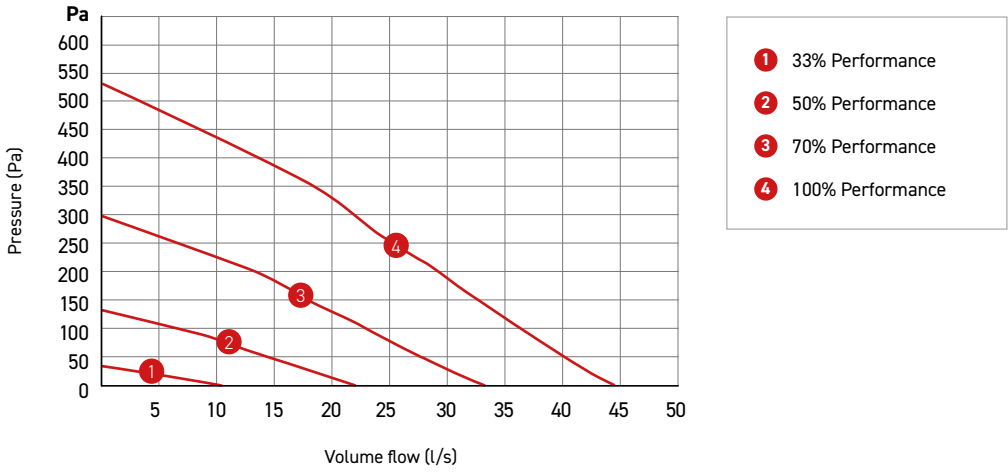

HRX-aQ PRODUCT CHARACTERISTICS DATABASE (SAP 2012)			
	Thermal Bypass	Specific Fan Power (W/l/s)	Heat Exchange Efficiency (%)
AQH200-B			
Kitchen + 1 wet room	✓	0.75	83
Kitchen + 2 wet rooms	✓	0.95	81

ACOUSTIC PERFORMANCE											
Curve	Max power consumption (Watts)		Sound Power Levels dB re 1pW (Frequency Hz)								dBA @3m
			63	125	250	500	1k	2k	4k	8k	
1	1	Open inlet	34	30	37	47	37	29	21	13	32
		Open outlet	37	38	49	61	51	49	46	39	
		Breakout	41	49	47	51	43	36	34	25	
2	6.6	Open inlet	38	34	41	51	41	33	25	17	36
		Open outlet	41	42	53	65	55	53	50	43	
		Breakout	45	53	51	55	47	40	38	29	
3	22	Open inlet	40	36	43	53	43	35	27	19	38
		Open outlet	43	44	55	67	57	55	52	45	
		Breakout	47	55	53	57	49	42	40	31	
4	53	Open inlet	42	38	45	55	45	37	29	21	40
		Open outlet	45	46	57	69	59	57	54	47	
		Breakout	49	57	55	59	51	44	42	33	

The breakout case-radiated dBA values are given for Hemispherical free field radiation at 3m - to obtain the Spherical radiated data, subtract 3 dBA.  
 \*Noise not normally heard by the human ear.

## Consultant specification for AQH200-B

### Specification

The unit is fully insulated, providing excellent thermal and acoustic characteristics and is complete with a multi-plate, counter-flow, high-efficiency heat exchanger block, with a thermal efficiency of up to 88%. The heat exchanger is protected by G3 grade filters at fresh air inlet and system extract.

The heat exchanger filters shall be accessible via the front access panel, enabling quick and easy maintenance.

The unit has low energy, high-efficiency EC fan/motor assemblies with sealed for life bearings, the impellers are backward-curved centrifugal type. The motors are suitable for an ambient temperature of 40°C. The unit is supplied complete with a condensate drip tray and is suitable for 204mm x 60mm rectangular ducting. The breakout noise level and power requirements are detailed by the unit manufacturer and in accordance with the ventilation equipment schedule.

AQH200-B is manufactured by Domus Ventilation and shall be listed on the SAP PCDB.

### Operation

The supply and extract system will be positioned as indicated on the drawings and is in accordance with the fan schedule in the specification.

The combined supply and extract with heat recovery unit supplies filtered fresh air to each of the habitable rooms and moisture-laden air is extracted from all wet areas, e.g. bathroom, en suite, kitchen, utility rooms etc. The supply air will be pre-heated by the warm extract air via the integrated counter-flow heat exchanger element. The extracted air will also be filtered before it reaches the heat exchanger block. The ventilation unit varies its speed and, therefore, the ventilation rate, as it receives signals from one of the following:

Switched live signal from light/remote switches via the Bluebrain Controller. When signals are received, the fan will alter its speed to adjustable, normal and boost rates. The unit has the facility to commission the supply and extract fans independently on minimum speed (continuous background ventilation) and boost speed via inbuilt minimum and maximum speed adjustment. The fans have infinitely variable speed control.

### Integral Automatic Bypass

The bypass damper opens automatically via a wax actuator, allowing the air to bypass the heat exchanger to deliver fresh filtered air during the warmer months. The automatic bypass diverts 100% airflow around the heat exchanger with no reduction in airflow, as independently tested by the BRE.

### Integral Humidity Sensor

The integral humidity sensor incorporated within the extract fan chamber will automatically boost both the extract and supply fan, to the commissioned boost speed, when the humidity level exceeds that set by the Bluebrain Controller.

### Control Options

The AQH200-B shall have the following functions integrally mounted within the separate fan wiring centre and controlled by the Bluebrain control panel, which is:

- ▶ Independent control of background supply and extract flow rates
- ▶ Independent control of boost speed supply and extract flow rates
- ▶ Integral heat exchanger frost protection
- ▶ Fan failure indication
- ▶ Integral S/L terminal for boost from remote switch, e.g. light switch
- ▶ Additional S/L terminal for 100% boost speed from remote switch, e.g. plate switch
- ▶ Discreet daily run monitor
- ▶ Indication and controls – The unit shall have clear LCD visual indication for maintenance, servicing and operation mode, i.e. HX bypass, frost protection

### Bluebrain Control Panel

The controller comes complete with commissioning and end user functions. The display will be a 2.75" LCD display and will remain on standby until such time a control button is engaged.

The initial display will show the MVHR system status as listed below:

- ▶ Current fan speed
- ▶ Current indoor/outside temperature
- ▶ Indicate when the Summer bypass is activated
- ▶ Indicate when frost protection is activated
- ▶ Indicate when the filters require cleaning/changing

The unit comes with a 2 year warranty which starts from the day of delivery.



# NOX-FILT™

The **NOX-FILT** range is Domus Ventilation's answer to the increasing demand for improved indoor air quality in the construction industry.

This range of in-line carbon filters are designed to be situated on the supply leg of a mechanical ventilation system and preventing up to 99.5% of airborne contaminants entering the property. Whilst the immediate emphasis is on the filtration of harmful NO<sub>2</sub>, often found in high levels within cities across the UK, there is also the option of a PM2.5 pre-filter to maximise the filtration of Particulate Matter equal or larger in size to 2.5 microns.



Removes up to  
**99.5%**  
of harmful NO<sub>2</sub>

## Range of options

There are two units available in the range with the only difference being what filters are included at purchase. The **NOX-FILT** houses a carbon filter cell only, whereas the **NOX-FILT2.5** includes a PM2.5 pre-filter.

## Dimensions (mm)

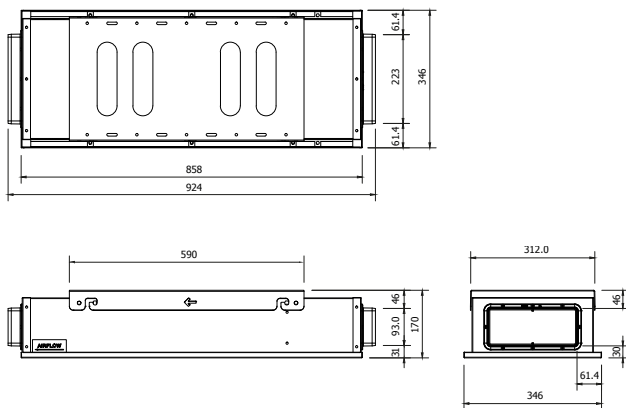

## Key features

- ▶ Up to 99.5% NO<sub>2</sub> filtration.
- ▶ Simple to replace, single carbon filter cartridge.
- ▶ Low resistance.
- ▶ Optional PM2.5 pre-filter offering increased Particulate Matter filtration.
- ▶ Low profile for space restrictions.
- ▶ Tested in accordance with BS EN ISO 7235:2009.
- ▶ The unit is suitable for 220x90mm ducting.



## Performance

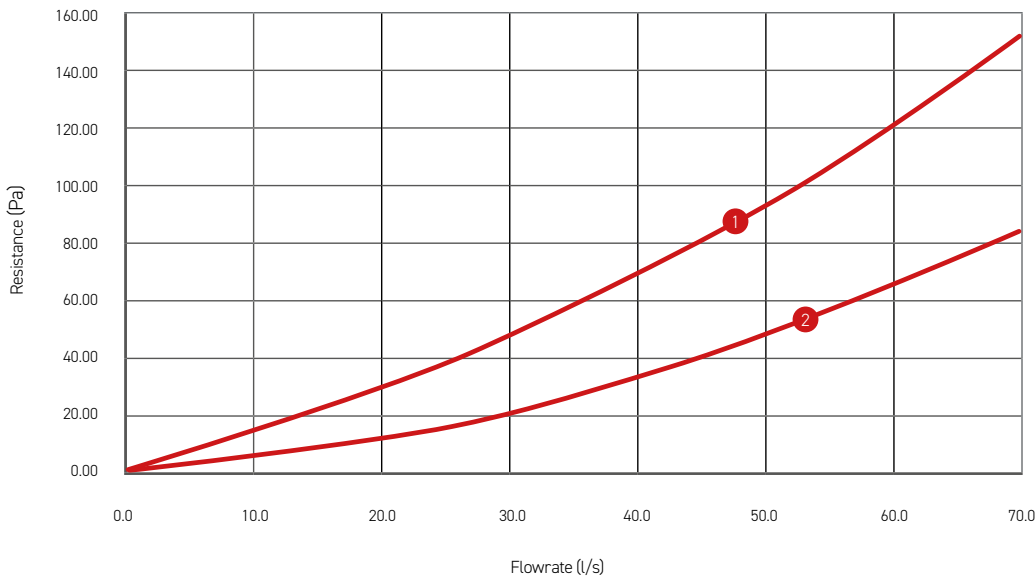

### KEY

- 1 NOX-FILT2.5  
Carbon filter with PM2.5 pre-filter included
- 2 NOX-FILT  
Carbon filter only

Code	Description
NOX-FILT	In-line carbon filter
NOX-FILT2.5	In-line carbon filter with additional PM2.5 pre-filter

Accessories	Description
NOX-PM2.5	Replacement PM2.5 filter
NOX-CF	Replacement carbon filter cell

## Consultant specification for NOX-FILT

The **NOX-FILT** is manufactured in sheet metal, with an integral foam lining to reduce noise and provide internal sealing. Each in-line filter has the ability to have an optional PM10 or PM2.5 pre-filter inserted into the filter box to be capable of additional particulate filtration; particularly from diesel vehicle fumes.

The **NOX-FILT** comes complete with a removable mounting bracket.

The **NOX-FILT** comes complete with a plastic construction carbon filter, containing two 30mm (approx.) beds of activated carbon pellets providing a large surface to filter the airflow. The filters can easily be removed and replaced when required. The filters have a minimum efficiency of between 96% and 99.5% effectiveness in the removal of Nitrogen Dioxide.

The unit efficiency will be confirmed and independently verified by a BRE (Building Research Establishment) test method and the information will be provided by the filter manufacturer for approval.

The unit will be installed in conjunction with the manufacturer's installation and maintenance guidelines.

Description	Unit	Value
Bulk density	kg/m <sup>3</sup>	480 (+/-5%)
Nominal diameter of cylindrical pellets	mm	4.0
Nominal length of cylindrical pellets	mm	8.0
Moisture content (approx.)	%	3
Crush strength (minimum)	kg	2
Removal capacity for Cl <sub>2</sub> of own weight	%	10
Minimum design efficiency	%	96
Typical air velocity	m/s	0.3 - 2.5
Suitable for relative air humidities	%	10 - 95
Temperature range	°C	-20 - +51

The unit comes with a 5 year warranty; 1 year parts and labour, remaining years parts only. This warranty is void if the equipment is modified without authorisation, is incorrectly applied, misused, disassembled or not installed, commissioned and maintained in accordance with the details contained in the I&M manual and general good practice.

**SYSTEM 3  
MECHANICAL EXTRACT VENTILATION (MEV)**

# CMX-MULTI™

The CMX-MULTI showcases **one of the best SFP** on the market whilst maintaining a unique 125mm depth for simple, flexible installation.

Aimed at the Residential market, its shape and size conform with New-Build restrictions, whilst also making it ideal for retro-fit projects owing to direct duct runs and wall or ceiling void fixings. Quiet running, whilst comfortably providing impressive airflow rates and with a choice of models with and without integral humidistat, the CMX-MULTI range provide the solution in Mechanical Extract Ventilation.

### Key features

- ▶ SFP down to 0.14 (W/l/s) at K+1.
- ▶ CMX-MULTI-H has integral humidistat, ideal for specification works.
- ▶ 3 inlet spigots for simplified multi-room extraction.
- ▶ 204x60mm spigots allowing direct duct runs from the unit, saving time and money on site.



Code	Description
CMX-MULTI	CMX-MULTI Mechanical Extract Ventilation Unit
CMX-MULTI-H	CMX-MULTI Mechanical Extract Ventilation Unit with integral Humidstat

### Installation

IS A WHOLE HOUSE EXTRACT SYSTEM

**Supports kitchen and up to six wet rooms**

- Building Regulations Compliant
✓
- ErP Directive Compliant
✓



### Dimensions (mm)

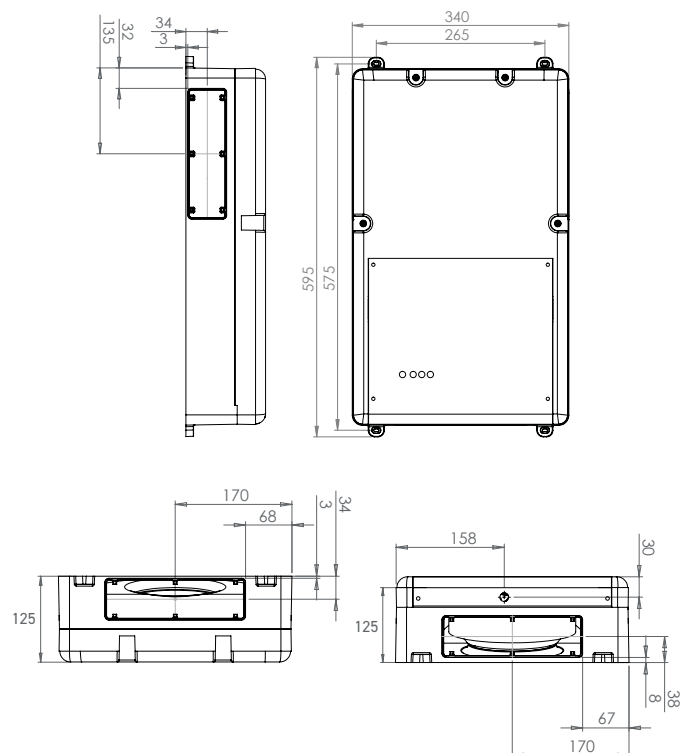



Technical Data	
Max Extract Volume (m³/h)	409
Max Extract Volume (l/s)	113.5
Max Pressure (Pa)	460
Max Power (W)	63.5
Supply Frequency (Hz)	50
Max Sound dB(A) @ 3m	45
Socket Size (mm)	204 x 60
Insulation Class	1
Weight (kg)	3.1
Max Operating Temperature (°C)	40

**One of the  
slimmest and  
lightest MEV on  
the UK market!**

**System illustration**

With 204x60mm spigots, the CMX-MULTI units can support direct duct runs, without the need for adapters or flexible duct fixings

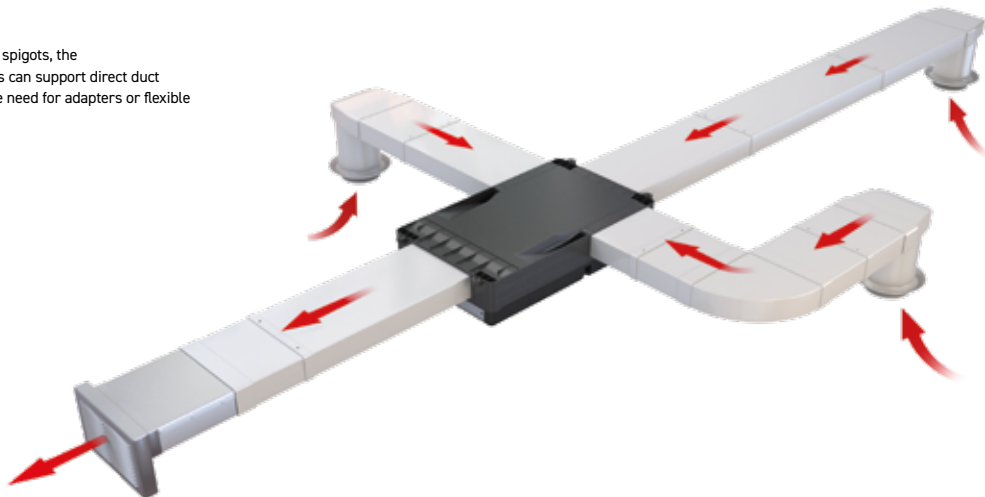

## Performance - 3 open outlets

## Sound performance

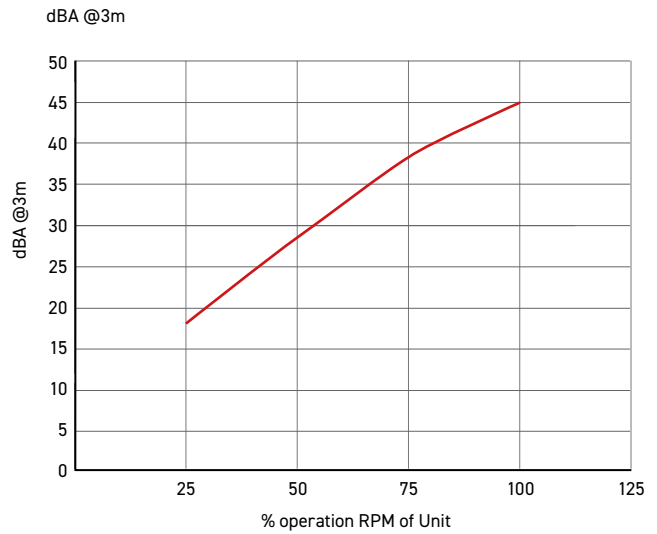
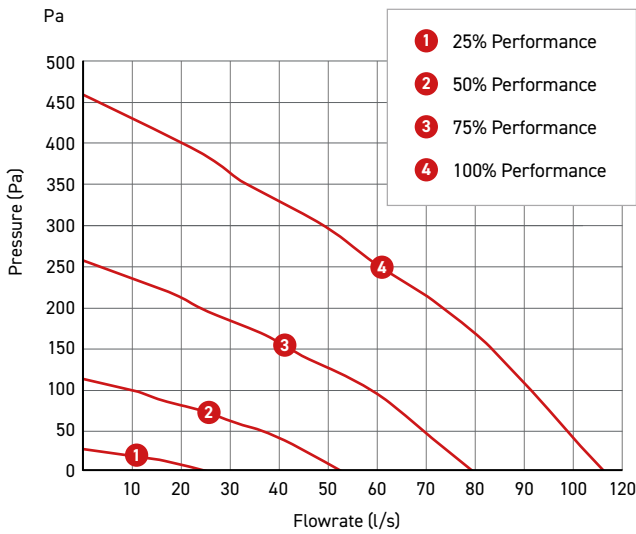

### CMX-MULTI Product Characteristics Database (SAP 2012)

Kitchen + n wet rooms	Power (W)	Flow (l/s)	SFP (W/l/s)
Kitchen + 1 wet room	2.89	21	0.14
Kitchen + 2 wet rooms	4.5	29	0.16
Kitchen + 3 wet rooms	7.22	37	0.20
Kitchen + 4 wet rooms	11.13	45	0.24
Kitchen + 5 wet rooms	16.3	53	0.31
Kitchen + 6 wet rooms	22.42	61	0.37

### ACOUSTIC PERFORMANCE

Curve	Max power consumption (Watts)		Sound Power Levels dB re 1pW (Frequency Hz)								dBA @3m
			63	125	250	500	1k	2k	4k	8k	
1	1	Open inlet	47	48	33	28	34	28	<16	<16	13
		Open outlet	46	45	38	36	33	29	22	21	
		Breakout	45	39	37	30	30	24	19	<16	
2	7	Open inlet	48	48	48	43	47	42	30	23	26
		Open outlet	46	47	52	49	47	44	36	28	
		Breakout	45	45	46	41	41	34	27	18	
3	28	Open inlet	53	58	63	60	63	58	52	44	48
		Open outlet	49	53	66	69	65	64	57	48	
		Breakout	51	56	62	63	63	56	47	40	
4	65	Open inlet	61	55	66	70	69	66	60	54	51
		Open outlet	56	56	69	75	72	71	65	57	
		Breakout	63	60	63	67	66	59	55	47	

## Consultant specification for CMX-MULTI/CMX-MULTI-H

The unit has been designed specifically for incorporation within a system designed to comply with the requirements of Part F Building Regulations. Ducting and grilles forming part of the system are specified elsewhere. Units CMX-MULTI are manufactured by Domus Ventilation and are listed on the SAP PCDB.

This unit is manufactured by a BSI Registered Firm with ISO 9000 certification. The unit's casing is made of ABS, moulded plastic and EPP moulded foam.

The unit incorporates mounting hole points located at each corner for mounting to a rigid surface. When installed, the unit should not project any more than 125mm from the surface onto which it is installed. Air discharge from the unit will be via a tapered rectangular spigot for easy connection to ducting.

The unit is capable of a three-inlet format. The unit casing has the facility to allow the connection, via tapered air inlet spigots supplied with three 204mm x 60mm spigots.

The unit is constructed with one removable panel allowing full maintenance access, but it is not required to be removed for installation as the unit is supplied with a flying lead. The unit incorporates a fully speed adjustable (note: stepped speed control will not be acceptable) low energy, high efficiency DC fan/motor assembly with sealed for life bearings designed to operate continuously at a pre-set 'background' design airflow rate, with the ability to increase to a pre-set 'boost' or a pre-set 'purge' design airflow rate as and when required. It operates up to an ambient temperature of 40°C and is to be fitted with a locked rotor protection device.

The impeller should be a centrifugal backward curved type, dynamically balanced and mounted directly onto the motor. The unit incorporates electrical connections to allow for the units 'boost' airflow to be triggered by a switched live signal, 230V. The CMX-MULTI-H has an integral humidity sensor which operates the 'boost' function. Both the CMX-MULTI & CMX-MULTI-H is offered with a 2 year warranty; 1 year parts and labour, remaining year parts only.

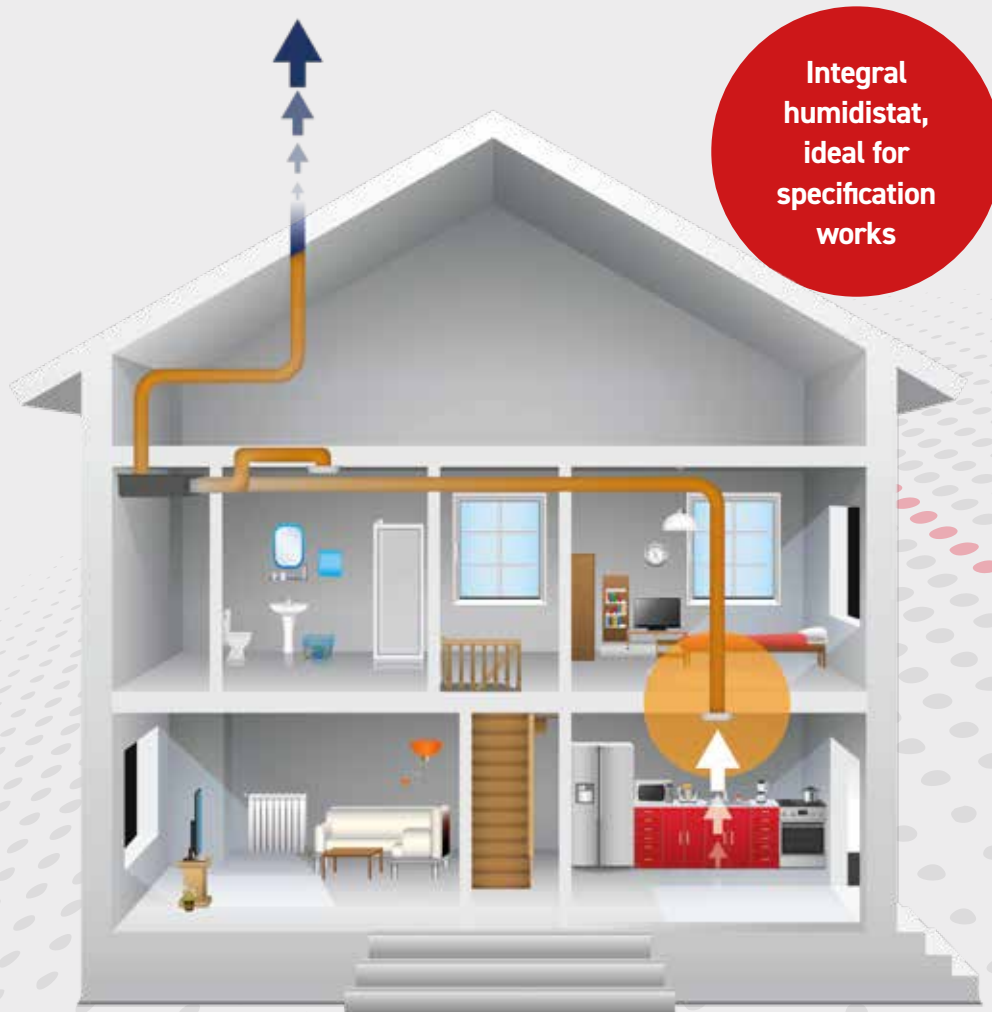

## SYSTEM 3 MECHANICAL EXTRACT VENTILATION (MEV)

# CMX-S™

With an impressive airflow performance of up to 120l/s, the CMX-S is suitable for both Residential and Light Commercial applications. At just 125mm in depth, the CMX-S is one of the most versatile, easy to install and energy efficient MEV solutions available on the market.

### Key features

- ▶ High air flow performance up to 120l/s.
- ▶ In-line ports enable straightforward duct connection.
- ▶ Only 125mm deep.
- ▶ Must be fitted:
  - Direct to a ceiling or in a loft space
  - Within a joist space

### Installation



IS A WHOLE  
HOUSE SYSTEM

**Supports kitchen and  
up to six wet rooms.**

**Floor area 275m<sup>2</sup>.**

Building Regulations Compliant



Code	Description
CMX-S	CMX-S Mechanical Extract Ventilation Unit

### Dimensions (mm)

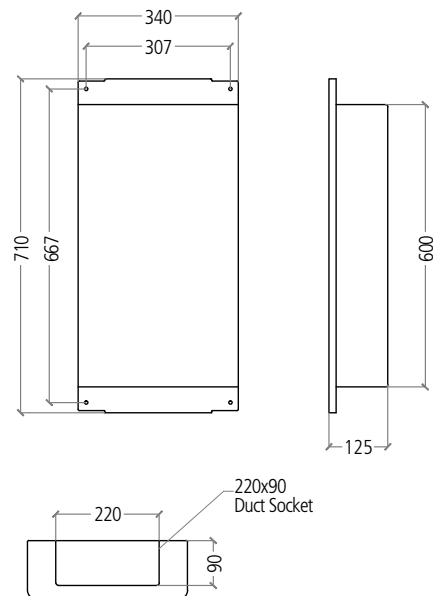

### Technical Data

Max Extract Volume (m <sup>3</sup> /h)	430
Max Extract Volume (l/s)	120
Max Pressure (Pa)	1000
Max Power (W)	83
Supply Frequency (Hz)	50
Max Sound dB(A) @ 3m	55
Socket Size (mm)	220 x 90
Insulation Class	1
Weight (kg)	3.25
Max Operating Temperature (°C)	40

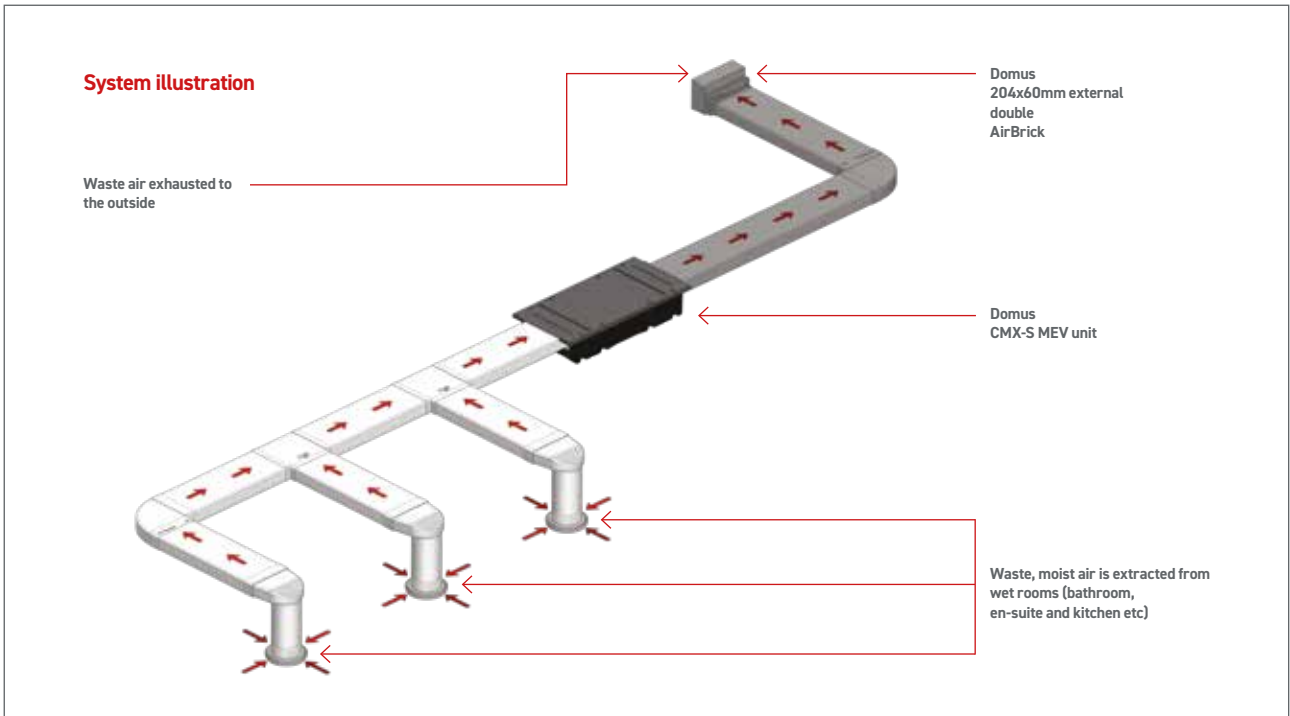

**Accessories**

Code	Description
ANC108A	Timer Switch
ANC802A	Timer and Humidity Switch
ANC808A	Timer and Humidity Switch with Neon indicator and pull cord
ANC813A	Timer and PIR Switch
ANC846A	Timer and Humidity Switch with Duct Mounted Sensor
ANC848A	Low/Boost Switch
ANC850A	Low/Boost/Purge Switch
CMX-ASK1B	Air Supply Kit with Brown Cowl
CMX-ASK1W	Air Supply Kit with White Cowl
ELE150R	Six Input Junction Box
SPR439	Commissioning Tool

For technical information visit: [www.domusventilation.co.uk](http://www.domusventilation.co.uk)



## Performance

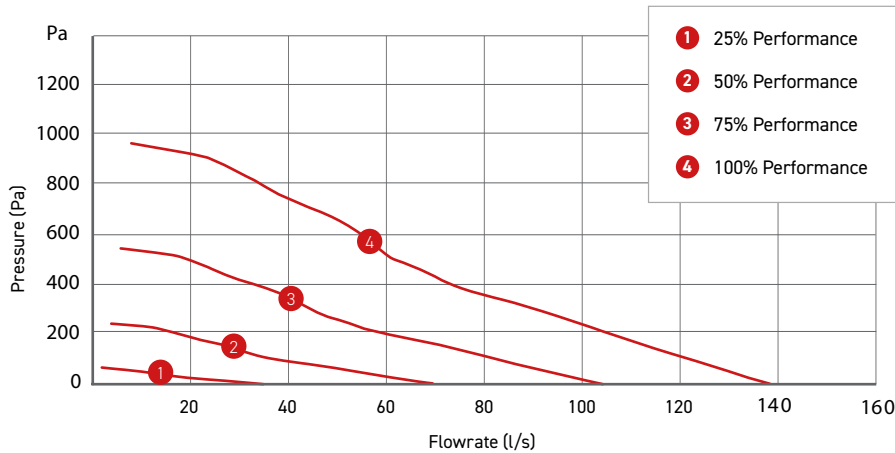

### ACOUSTIC PERFORMANCE

Curve	Max power consumption (Watts)		Sound Power Levels dB re 1pW (Frequency Hz)								dBA @3m
			63	125	250	500	1k	2k	4k	8k	
1	1.3	Open inlet	47	48	32	27	33	27	<16	<16	19
		Open outlet									
		Breakout	46	52	34	29	26	18	<16	<16	
2	9.4	Open inlet	48	47	44	38	43	38	25	20	22
		Open outlet									
		Breakout	42	50	44	39	34	27	<16	<16	
3	34.7	Open inlet	52	55	63	58	61	56	49	40	39
		Open outlet									
		Breakout	45	55	60	55	50	46	36	23	
4	83.2	Open inlet	57	57	64	66	66	63	58	50	44
		Open outlet									
		Breakout	52	60	63	62	56	53	46	33	

## Consultant specification for CMX-S

The unit has been designed specifically for incorporation within a system designed to comply with the requirements of Part F Building Regulations. Ducting and grilles forming part of the system are specified elsewhere. Unit CMX-S is manufactured by Domus Ventilation and is listed on the SAP PCDB.

The unit is manufactured by a BSI Registered Firm with ISO 9000 certification. The unit's casing is made of ABS, moulded plastic and EPP moulded foam. The unit incorporates four mounting hole points for mounting to a rigid surface. When installed the unit should not project any more than 125mm from the surface onto which it is installed. Air discharge from the unit will be via a tapered rectangular spigot for easy connection to ducting. The unit is capable of a single inlet format. The unit casing has the facility to allow the connection, via tapered air inlet spigots supplied with one 220mm x 90mm spigot.

The unit is constructed with one removable panel allowing full maintenance access. The unit incorporates a fully speed adjustable (note: stepped speed control will not be acceptable) low energy, high efficiency EC fan/motor assembly with sealed for life bearings designed to operate continuously at a pre-set 'background' design airflow rate with the ability to increase to a pre-set 'boost' or a pre-set 'purge' design airflow rate as and when required. It operates up to an ambient temperature of 40°C and is to be fitted with a locked rotor protection device.

The impeller should be a centrifugal backward curved type, dynamically balanced and mounted directly onto the motor. The unit incorporates electrical connections to allow for the unit's 'boost' airflow to be triggered by a switched live signal, 230V.

The CMX-S unit is offered with a 2 year warranty; 1 year parts and labour, remaining year parts only.

# DMEV-NICO

Domus Ventilation's dMEV-NICO is a Decentralised Mechanical Extract Ventilation fan (dMEV) to provide continuous background extract ventilation for new build properties.

Built to achieve the ventilation rates as set out in the latest edition of Part F and L Building Regulations.

## Compliance

Building Regulations Part F1 (1) are set to protect the health of the occupants of the building by providing adequate ventilation. Without adequate ventilation, mould and internal air pollution might become hazardous to health.

## Key features

- ▶ Compliance – Building Regulations ADF & L (2021 edition) – to protect the health of your occupants.
- ▶ Listed on the SAP PCDB database.
- ▶ Cost effective extract solution.
- ▶ Low maintenance and low life cycle costs.
- ▶ Monitoring device – detect occupants operation.
- ▶ Flexible compliant solution for kitchens, bathrooms, WC and utility areas.
- ▶ Suitable for wall, ceiling and window applications.
- ▶ Digital control for easy set up and commissioning.
- ▶ 5 year warranty – peace of mind.



Number of bedrooms <sup>(1/2)</sup>	Minimum ventilation rate by number of bedrooms (l/s)
1	19
2	25
3	31
4	37
5	43

**Notes:**

1. If the dwelling only has one habitable room, a minimum ventilation rate of 13 l/s should be used.
2. For each additional bedroom, add 6 l/s to the values in Table 1.3.

Room	High rate (l/s)	Continuous rate
Kitchen	13	The sum of all extract ventilation in the dwelling on its continuous rate should be at least the whole dwelling ventilation rate given in Table 1.3.
Utility room	8	
Bathroom	8	
Sanitary accommodation	6	

**Notes:**

1. If the continuous rate of ventilation provided in a room is equal to or higher than the minimum high rate specified in the table, no extra ventilation is needed.

## Performance

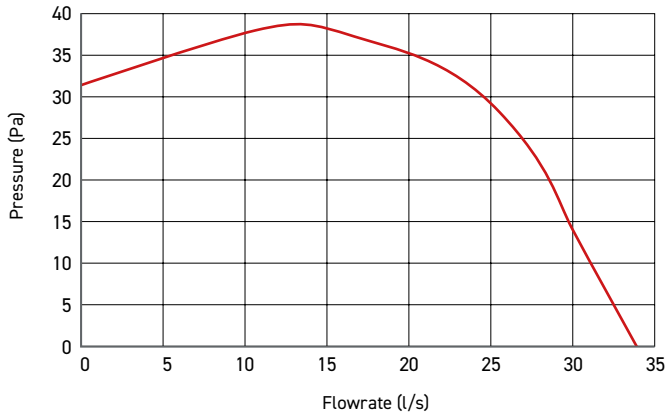

SFP Performance	
FAN LOCATION	SFP (W/l/s)
In-room fan - kitchen	0.23
In-room fan - other wet room	0.28
Through-wall fan - kitchen	0.16
Through-wall fan - other wet room	0.23

Sound Performance										
Frequency Hz										
Unit	Duty (l/s)	125	250	500	1K	2K	4K	8K	LwA	dBA @ 3m
DMEV-NICO	34	39	44	52	47	48	43	30	54	33

## Dimensions (mm)

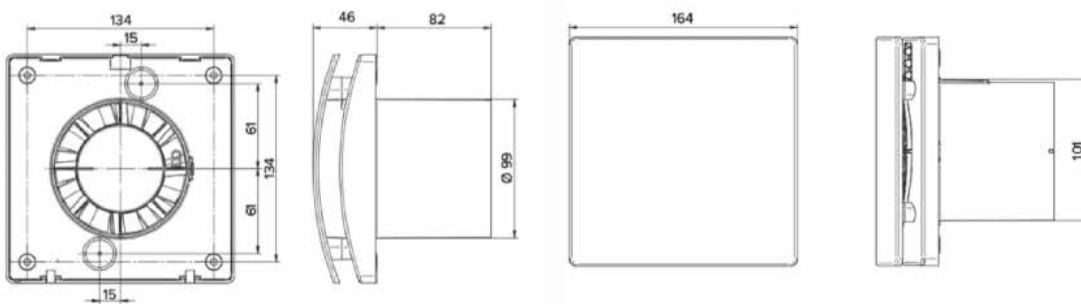

## Accessories

Code	Description
DMEV-WKIT	DMEV Window Kit
DMEV-WP	DMEV Wall Plate

# ▶ INTERMITTENT EXTRACT FANS

Our range of bathroom and kitchen fans provide rapid local extraction and include axial, in-line and centrifugal options. The Domus range has earned itself a superb reputation for quality, reliability and ease of installation.

## How a fan works

Previously known as System 1 in Approved Document F of the Building Regulations, intermittent extract is a classic method of ventilating a home, either under occupant or automatic control i.e. a timer or a pull cord.



## Electrical safety zones

### Where is it safe to install a fan?

Fans are commonly 240 Volts, however, to protect occupants who need a fan installing close to a shower or bath, there are Separated Extra Low Voltage (SELV), 12 Volt, fans available.

Please use our illustration to help you know where you should and SHOULDN'T install a fan, as well as knowing where you need a 240 or 12 Volt fan.

**For more information, see section 701 of British Standard 7671:2018.**

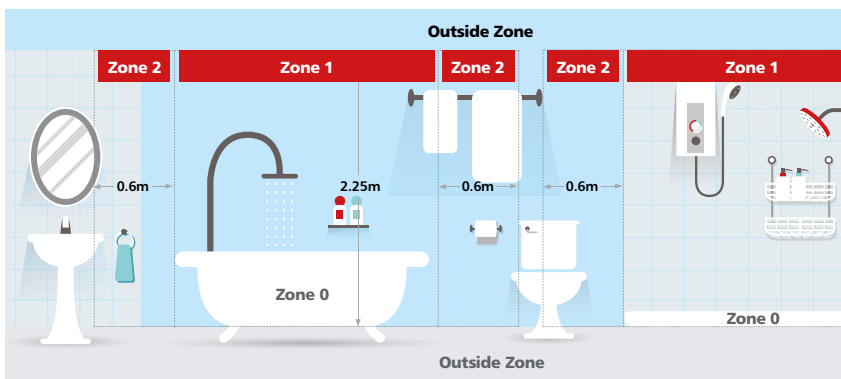

#### Zone 0

No fans permitted.

#### Outside Zone

Fans positioned in this area will be less effective.

#### Zone 1

12 Volt (SELV) fans. Must be positioned above Zone 0 over 2.25m from the floor.

#### Zone 2

230 Volt fans. Must be positioned horizontally 0.6m from Zone 1.

If in doubt, contact a qualified electrician for installation.

## How to choose the right fan

### 1 Step one

What sort of property are you installing into:

A new-build property?



NEW-BUILD & REPLACING FANS

An existing property?



REPLACING FANS

### 2 Step two

What wet room are you installing into:



BATHROOM



TOILET



KITCHEN



UTILITY ROOM

### 3 Step three

What sort of fan and model do you want:

#### Axial models



Connect to a short duct run, up to 1.5m in length, typically running through a wall to an external grille.

#### Typical axial installation



#### In-Line models



Perfect for shower applications and commonly mounted in a loft or ceiling void with up to 3m of duct.

#### Typical in-line installation



#### Centrifugal models



Suitable for longer duct runs up to 6m in length and can be wall or ceiling mounted.

#### Typical centrifugal installation



### 4 Step four

What voltage your fan should be:

240V or 12V (SELV).

For more information on whether you need a 240V or a 12V (SELV) fan, see page 36.



### 5 Step five

What extra options do you need:



Timer



Pull Cord



Humidistat



Twin Speed

INTERMITTENT EXTRACT | IN-LINE AXIAL FANS

# DBF100 100mm (4")

Provides effective ventilation to comply with current building regulation standards.



Code	Description
DBF100B	Basic Fan
DBF100-PC	Pull Cord Control
DBF100-T	Timer Control
DBF100-HT	Humidistat and Timer Control

Sound Performance											
Frequency Hz											
Unit	Duty (l/s)	63	125	250	500	1K	2K	4K	8K	LwA	dBA @ 3m
DFB100	18.6	39	41	53	49	52	45	41	33	55	34

## Performance

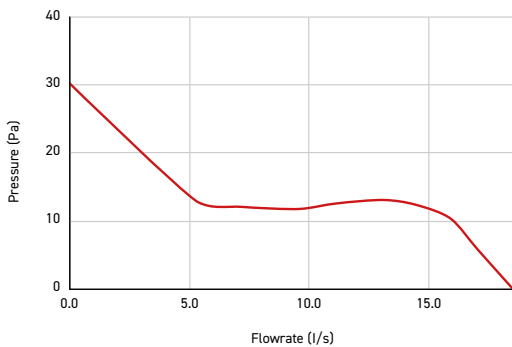

## Dimensions (mm)

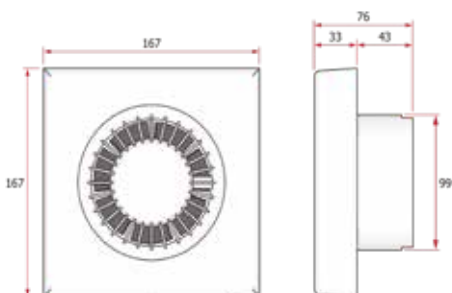

## Technical Data

Description	Value	Units
Max Extract Volume	18.6	(l/s)
Max Extract Volume	66.96	(m3/H)
Max Pressure	30.2	(Pa)
Supply Frequency	50	(Hz)
Specific Fan Power	0.49	(W/l/s)
Max Power	8	(W)
Max Sound Level	34	dB(A) @3m
Weight	0/6	(kg)
IP Rating	X4	N/A
Max Operating Temperature	40	(°C)
Wall-Fit Hole Diameter	110	(mm)
Warranty	2	Years

INTERMITTENT EXTRACT | IN-LINE AXIAL FANS

# DKF150 150mm (6")

Provides effective ventilation to comply with current building regulation standards.



Code	Description
DKF150B	Basic Fan
DKF150-T	Timer Control
DKF150-HT	Humidistat and Timer Control

Sound Performance											
Frequency Hz											
Unit	Duty (l/s)	63	125	250	500	1K	2K	4K	8K	LwA	dBA @ 3m
DFB100	48.8	47	49	60	55	54	54	47	37	59	39

## Performance

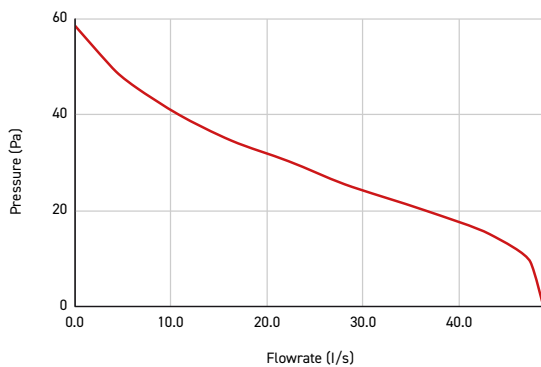

Technical Data		
Description	Value	Units
Max Extract Volume	48.8	(l/s)
Max Extract Volume	17.6	(m3/H)
Max Pressure	59	(Pa)
Supply Frequency	50	(Hz)
Specific Fan Power	0.38	(W/l/s)
Max Power	20.6	(W)
Max Sound Level	39	dB(A) @3m
Weight	1	(kg)
IP Rating	X4	N/A
Max Operating Temperature	40	(°C)
Wall-Fit Hole Diameter	155	(mm)
Warranty	2	Years

## Dimensions (mm)

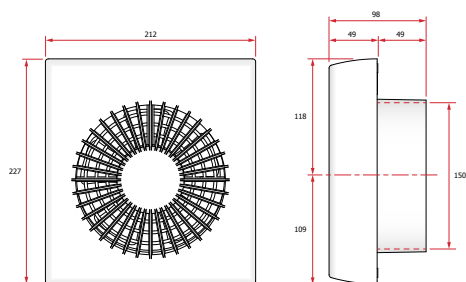

SYSTEM 1 | INTERMITTENT EXTRACT | IN-LINE AXIAL FANS

# DVF 100mm (4")

Mounts in ceiling void/loft

## Key features

- ▶ Concealed fan for discreet operation.
- ▶ Quiet in operation.
- ▶ Ideal for shorter duct runs and shower applications.
- ▶ Duct kit options for easy installation.



## Dimensions

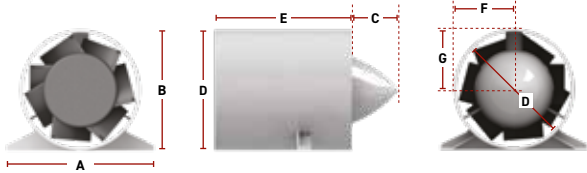

Measured in mm

A: 122 B: 103 C: 25 D: 99 E: 114 F: 49.5 G: 49.5



## Models

Product Code

DVF802ET

Timer

DIY Kit

•

•



# IN-LINE FANS MIXED FLOW

## EXTRACT FANS | VITALIS RANGE

# VIT 150mm (6") HIGH PERFORMANCE

### Key features

- ▶ High air flow performance.
- ▶ Concealed fan for discreet operation.
- ▶ Ideal for longer duct runs.
- ▶ Suitable for bathroom, toilet and utility.
- ▶ Ideal for replacement.



Technical Data	
Description	230V
Max Extract Volume (l/s)	High 153/Low 130
Max Extract Volume (m³/h)	High 552/Low 467
Max Pressure (Pa)	320
Supply Frequency (Hz)	50
Max Power (W) (Fan Only)	High 76/Low 54
Max Sound dB(A) @ 3m	High 33/Low 27
Weight (kg) (Fan Only)	3
IP Rating	X4
Max Operating Temperature (°C)	40
Warranty	2 yrs

Models	
VIT150B	Timer
VIT150TB	.

### Dimensions (mm)

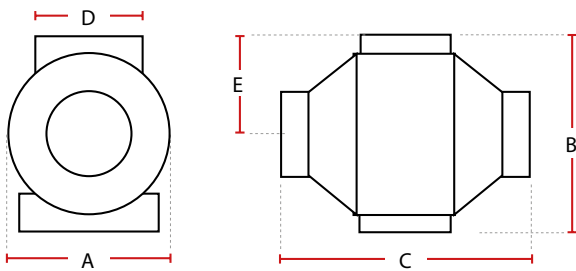

Measured in mm  
**A:** 220 **B:** 250 **C:** 295 **D:** 145 **E:** 130

### Performance

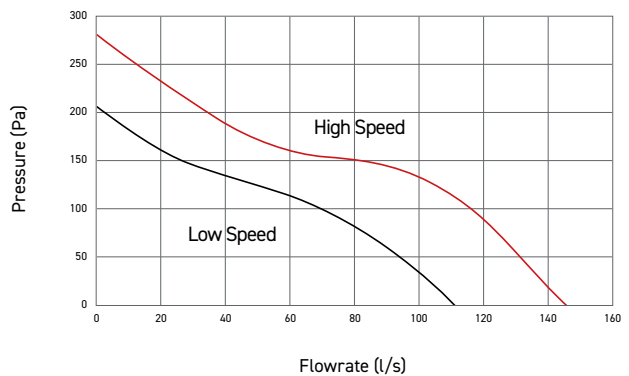

CENTRIFUGAL FANS

# Curzon 100mm (4")

Mounts onto a wall or ceiling

## Key features

- ▶ Provides effective ventilation.
- ▶ Quiet in operation.
- ▶ Ideal for long duct runs up to 6m.

## Dimensions (mm)

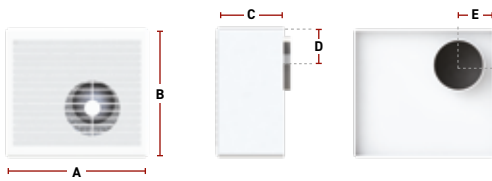

Measured in mm

A: 216 B: 195 C: 98 D: 80/100 E: 32/57 F: 50



## Models

Product Code	Back Draught	Pull Cord	Timer	Humidistat
CUR7001B	•			
CUR7002B	•	•		
CUR7003B	•		•	
CUR7004B	•	•	•	•
CUR7005B	•		•	

## Technical data

Description	230V
Max Extract Volume (l/s)	19
Max Extract Volume (m³/h)	67
Max Pressure (Pa)	117
Supply Frequency (Hz)	50
Max Power (W)	25
Max Sound Level dB(A) @3m	31
Weight (kg)	1.1
IP Rating	X4
Max Operating Temperature (°C)	40
Warranty	2 yrs

## Performance



CENTRIFUGAL FANS

# Mayfair 100mm (4") Plug-In

Mounts onto a wall or ceiling with back box

## Key features

- ▶ Comply with current Building Regulation requirements.
- ▶ Offers a very low SFP down to 0.39 W/(l/s).
- ▶ Quiet in operation.
- ▶ Interior design scheme.

## Dimensions (mm)

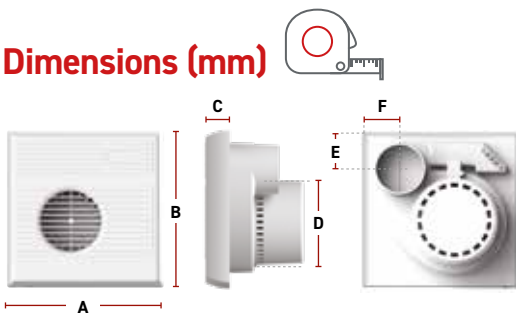

Measured in mm

A: 250 B: 250 C: 40 D: 90 E: 65 F: 65



## Accessories

SPR405	Replacement Front Cover
MAY904A	Surface Installation Back Box, Plastic
MAY905B	Building in Wall Back Box
MAY906A	Surface Installation Back Box, Metal

## Models

Product Code	Back Draught	Twin Speed	Pull Cord	Timer	Humidistat
MSS070B	•				
MPC070B	•		•		
MTD070B	•			•	
MCC070B	•			•	•
MTS070B	•	•			
MTT070B	•	•		•	

## Performance

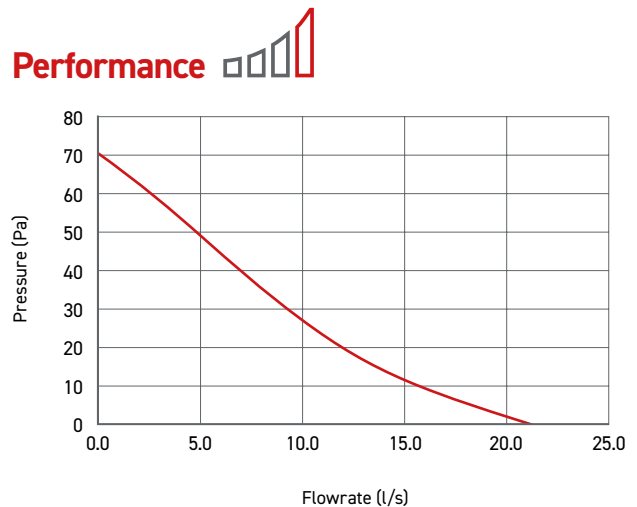

# DON'T DELAY IN SWITCHING TO THE D SERIES



**DX 6 WW**  
 | | |  
 1 2 3



## ► BASIC FAN SELECTION

Please see the following step by step guide on how to select a fan unit. The extract rates are given as an example only, and the suitability of the product to meet all noise and Building Regulations for the proposed application should be confirmed. This is a basic guide and does not include selections based on specific fan power requirements under Part L of the Building Regulations etc.

**Required information:** Room size | Application

### Air change rate guide for various applications

Application	Air changes per hour
Banks	4 to 6
Cafés / coffee bars	10 to 12
Cellars	3 to 10
Changing rooms	6 to 10
Cinemas / theatres	6 to 10
Conference rooms	8 to 10
Dance halls	10 to 12
Dark rooms	10 to 15
Dental surgeries	12 to 15
Entrance halls	3 to 5
Factories / workshops	8 to 10
Garages	6 to 10
Gymnasiums	6 to 8
Hospital wards	6 to 8

Application	Air changes per hour
Kitchens - commercial	15 to 30
Laundries	10 to 15
Libraries	3 to 4
Offices	4 to 6
Public house bars	6 to 10
Restaurants	10 to 15
School rooms	4 to 6
Shops / supermarkets	8 to 10
Showers / bathrooms	15 to 20
Stores / warehouses	3 to 6
Swimming baths	15 to 20
Toilets - public	6 to 8
Utility rooms	15 to 20

#### Code breakdown

1.	D Series	
2.	Size indication	
3.	Application	WW = Window model WL = Wall model PL = Ceiling model PR = Pitched Roof model FR = Flat Roof model

### How to calculate the required flowrate

#### What is the room volume m<sup>3</sup>?

► Example - 10m long x 5m wide x 2.5m high = **125m<sup>3</sup>**

#### What is the application?

► Example - Wall mounted in an office, six air changes necessary owing to size (see table above)

#### What is the flowrate calculation?

► Room Volume **m<sup>3</sup> x air change = 750m<sup>3</sup>/h**

► To calculate the flow rate as m<sup>3</sup>/s divide your answer by 3600. Finally multiply the m<sup>3</sup>/s figure by 1000. This will leave you with your flow rate as l/s

e.g. **125m<sup>3</sup> x 6 = 750m<sup>3</sup>/h**  
**750 ÷ 3600 = 0.208m<sup>3</sup>/s**  
**0.208m<sup>3</sup>/s x 1000 = 208l/s**

PERFORMANCE

# D SERIES WINDOW (WW) FANS

Available as kits or basic fan modules with adaptable ancillaries such as window spacers and weather terminals, our D Series Window fans can be part of a new install or refurbishment project.



## D Series 6, 9 and 12 inch Window Fans

Performance represents complete fan kit

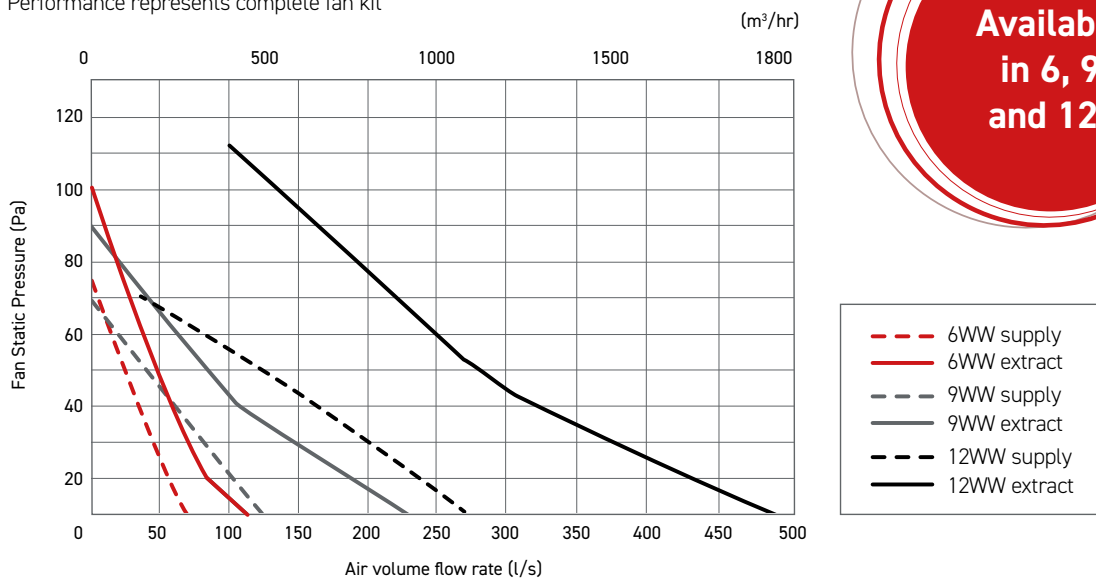

## Electrical and sound

Code	Noise/sound levels (dBA @ 3m)				Input power (watts)	
	Extract	Extract economy	Supply	Supply economy	Standard	Economy
DX6WW	42	31	43	32	38	20
DX9WW	41	30	43	32	50	37
DX12WW	47	36	48	37	100	70

## External Static Pressure (Pa)

DX6WW Extract	0	20	40	60
Air Flowrate (l/s)	121	79	52	34
Input Power (W)	42	43	46	48
SFP (W/l/s)	0.3	0.6	0.9	1.4

DX9WW Extract	0	20	40	60
Air Flowrate (l/s)	226	160	103	61
Input Power (W)	54	54	57	62
SFP (W/l/s)	0.2	0.3	0.6	1

DX12WW Extract	0	20	40	60
Air Flowrate (l/s)	498	413	317	250
Input Power (W)	110	110	113	117
SFP (W/l/s)	0.2	0.3	0.4	0.5

## D SERIES Window (WW) fan kits



## Typical installation

Exposed site window installation  
(use with Window Fan Kit)

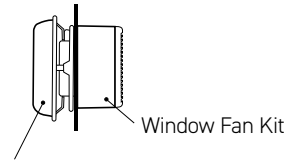

Weather cowl can replace the external grille and window sealing plate

## Dimensions (mm)

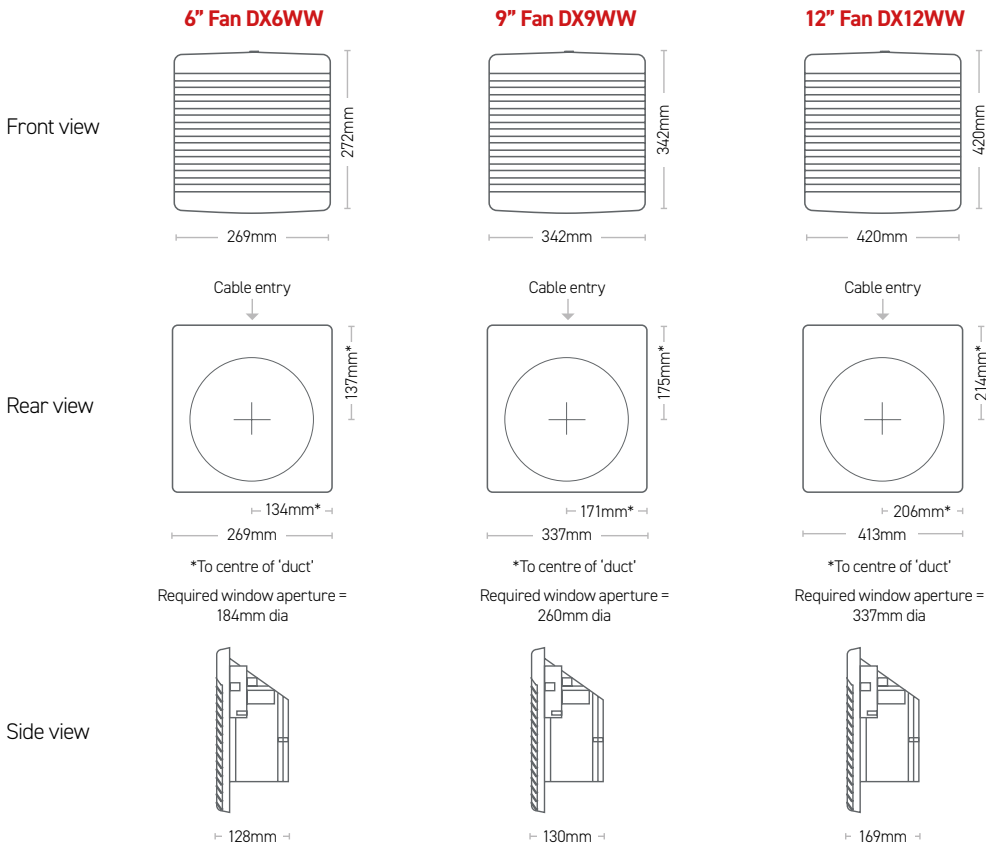

PERFORMANCE

# D SERIES PITCHED ROOF (PR) FANS

The low profile Pitched Roof kits are designed to be installed on angular roofs and suitable for all weather exposure.



## D Series 6, 9 and 12 inch Pitched Roof Fans

Performance represents complete fan kit

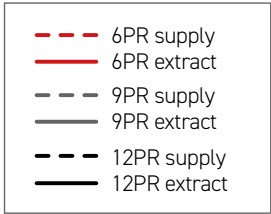
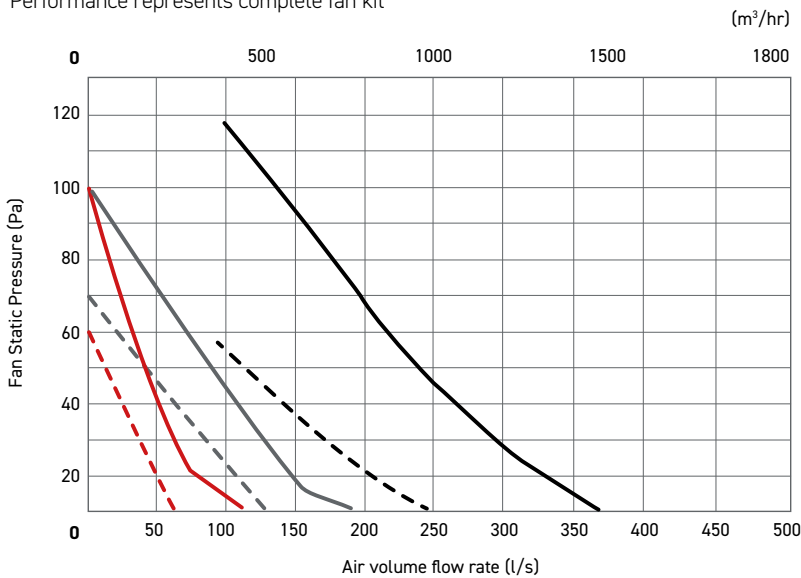

## Electrical and sound

Code	Noise/sound levels (dBA @ 3m)				Input power (watts)	
	Extract	Extract economy	Supply	Supply economy	Standard	Economy
DX6PR	42	31	45	34	38	38
DX9PR	41	30	43	32	50	37
DX12PR	49	38	48	37	100	70



### External Static Pressure (Pa)

DX6PR Extract	0	20	40	60
Air Flowrate (l/s)	112	74	51	36
Input Power (W)	42	43	46	48
SFP (W/l/s)	0.4	0.6	0.9	1.3

DX9PR Extract	0	20	40	60
Air Flowrate (l/s)	180	133	100	70
Input Power (W)	54	55	58	61
SFP (W/l/s)	0.3	0.4	0.6	0.9

DX12PR Extract	0	20	40	60
Air Flowrate (l/s)	358	305	258	214
Input Power (W)	107	109	111	113
SFP (W/l/s)	0.3	0.4	0.4	0.5

### Dimensions (mm)



D SERIES	6	9	12
A x A	272x272	342x342	420x420
B	161	158	172
C	150	150	150
D	170	180	185
kg	6.3	9.1	11.8

A = Opening size, B = Overall size

### D SERIES Pitched Roof (PR) fan kits



### Typical installation

Pitched roof (ducted to ceiling) installation (use with Pitched Roof Fan Kit)

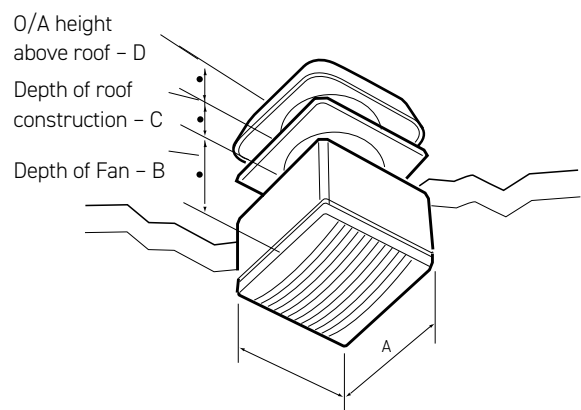
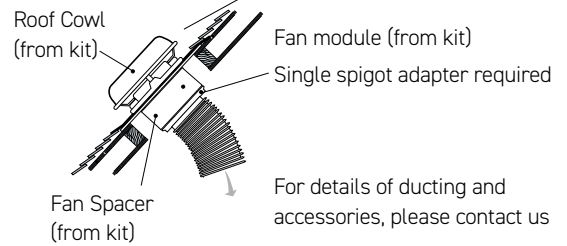

PERFORMANCE

# D SERIES FLAT ROOF (FR) FANS



Complementing the Pitched Roof offering, these fan kits ensure the D Series portfolio is comprehensive and practical in application.

## D Series 6, 9 and 12 inch Flat Roof Fans

Performance represents complete fan kit

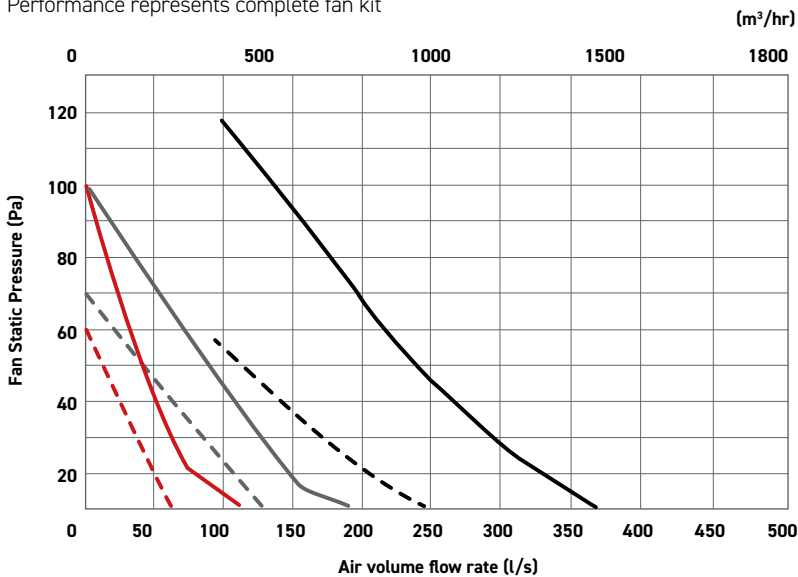

## Electrical and sound

Code	Noise/sound levels (dBA @ 3m)				Input power (watts)	
	Extract	Extract economy	Supply	Supply economy	Standard	Economy
DX6FR	42	31	45	34	38	38
DX9FR	41	30	43	32	50	37
DX12FR	49	38	48	37	100	70

### External Static Pressure (Pa)

DX6FR Extract	0	20	40	60
Air Flowrate (l/s)	112	74	51	36
Input Power (W)	42	43	46	48
SFP (W/l/s)	0.4	0.6	0.9	1.3

DX9FR Extract	0	20	40	60
Air Flowrate (l/s)	180	133	100	70
Input Power (W)	54	55	58	61
SFP (W/l/s)	0.3	0.4	0.6	0.9

DX12FR Extract	0	20	40	60
Air Flowrate (l/s)	358	305	258	214
Input Power (W)	107	109	111	113
SFP (W/l/s)	0.3	0.4	0.4	0.5

### Dimensions (mm)



D SERIES	6	9	12
A x A	272x272	342x342	420x420
B	161	158	172
C	150	150	150
D	170	180 <td 185	
kg	6.3	9.1	11.8

A = Opening size, B = Overall size

### D SERIES Flat Roof (FR) fan kits



### Typical installation

#### Flat roof (ducted to ceiling) installation (use with Ceiling Fan Kit)

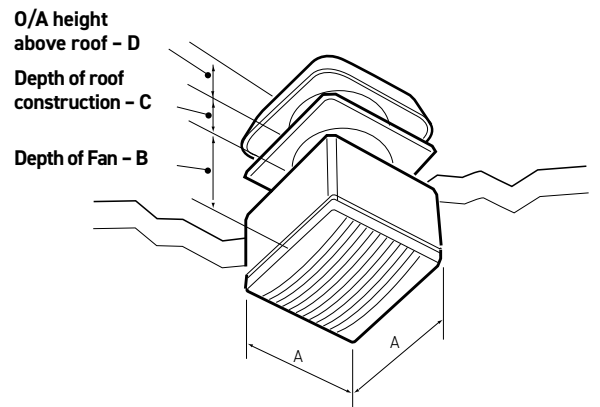
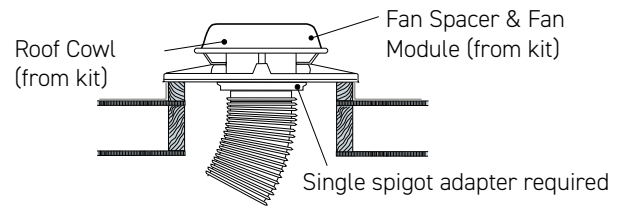

PERFORMANCE

# D SERIES WALL (WL) FANS

An ultra quiet wax thermo actuator combines with highly innovative motor and impeller technology to produce one of the quietest wall fans available.



## D Series 6, 9 and 12 inch Wall Fans

Performance represents complete fan kit

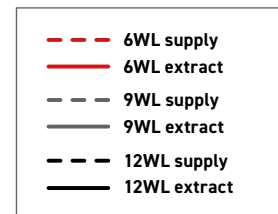
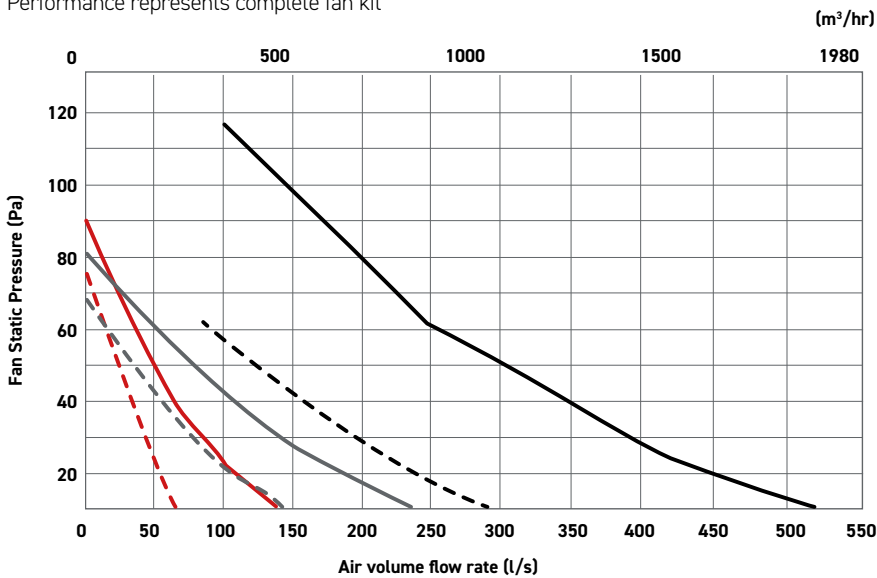

## Electrical and sound

Code	Noise/sound levels (dBA @ 3m)				Input power (watts)	
	Extract	Extract economy	Supply	Supply economy	Standard	Economy
DX6WL	42	31	45	34	38	20
DX9WL	45	34	45	34	50	37
DX12WL	47	36	47	36	100	70

## External Static Pressure (Pa)

DX6WL Extract	0	20	40	60
Air Flowrate (l/s)	131	110	65	38
Input Power (W)	42	42	44	48
SFP (W/l/s)	0.3	0.4	0.7	1.3

DX9WL Extract	0	20	40	60
Air Flowrate (l/s)	236	180	105	60
Input Power (W)	54	54	57	62
SFP (W/l/s)	0.2	0.3	0.5	1

DX12WL Extract	0	20	40	60
Air Flowrate (l/s)	530	465	344	265
Input Power (W)	111	110	112	116
SFP (W/l/s)	0.2	0.2	0.3	0.4

## D SERIES Wall (WL) fan kits



## Typical installation

Exposed site wall installation (use with Wall Fan Kit)

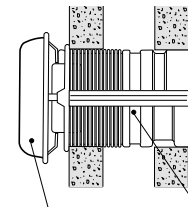

Weather cowl can replace the external grille

Wall Fan Kit

## Dimensions (mm)

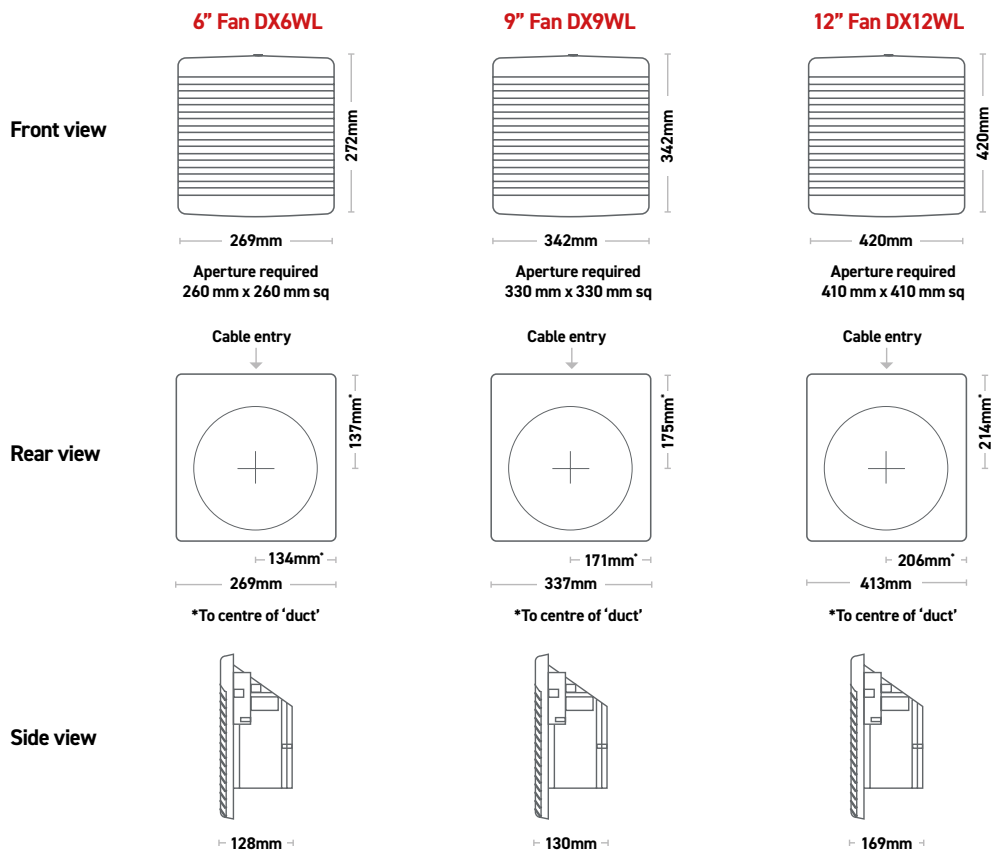

PERFORMANCE

# D SERIES CEILING (PL) FANS

A discreet design, suitable for solid or panel ceilings. These fans can be installed with our Roof or Weather Terminals, allowing optional exhaust points for flexible application.



## D Series 6, 9 and 12 inch Ceiling Fans

Performance represents complete fan kit

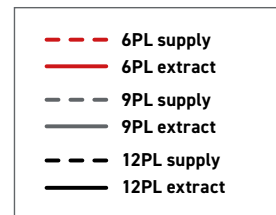
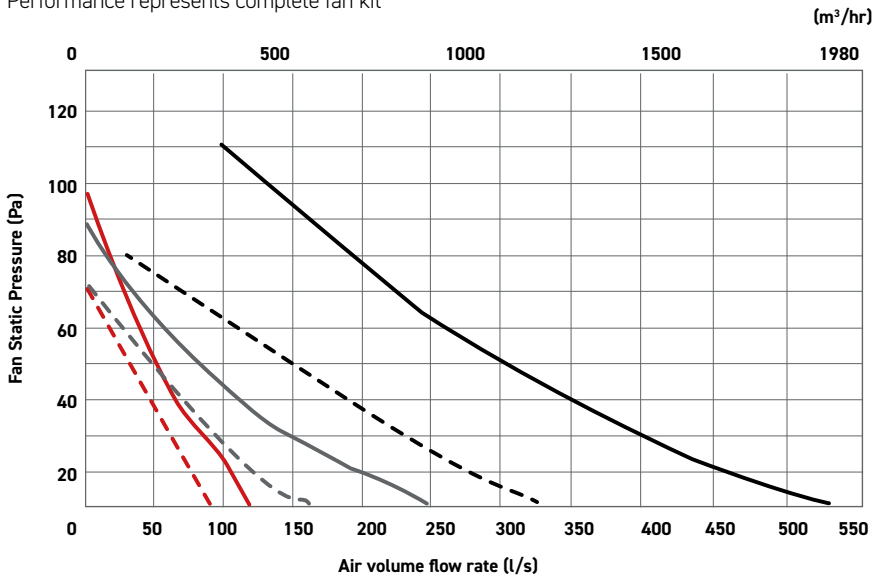

## Electrical and sound

Code	Noise/sound levels (dBA @ 3m)				Input power (watts)	
	Extract	Extract economy	Supply	Supply economy	Standard	Economy
DX6PL	42	31	45	35	38	20
DX9PL	41	30	43	32	50	37
DX12PL	49	38	48	37	100	70

## External Static Pressure (Pa)

DX6PL Extract	0	20	40	60
Air Flowrate (l/s)	119	76	50	32
Input Power (W)	42	43	46	49
SFP (W/l/s)	0.4	0.6	0.9	1.5

DX9PL Extract	0	20	40	60
Air Flowrate (l/s)	247	196	110	60
Input Power (W)	55	54	57	62
SFP (W/l/s)	0.2	0.3	0.5	1

DX12PL Extract	0	20	40	60
Air Flowrate (l/s)	544	472	329	260
Input Power (W)	111	110	113	116
SFP (W/l/s)	0.2	0.2	0.3	0.4

## D SERIES Ceiling (PL) fan kits

Fan Duct  
Connecting  
Plenum



Fan  
Module



Internal  
Grille



## Typical installation

Exposed site wall installation (use with Wall Fan Kit)

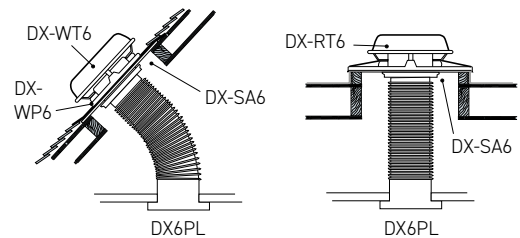

## Dimensions (mm)

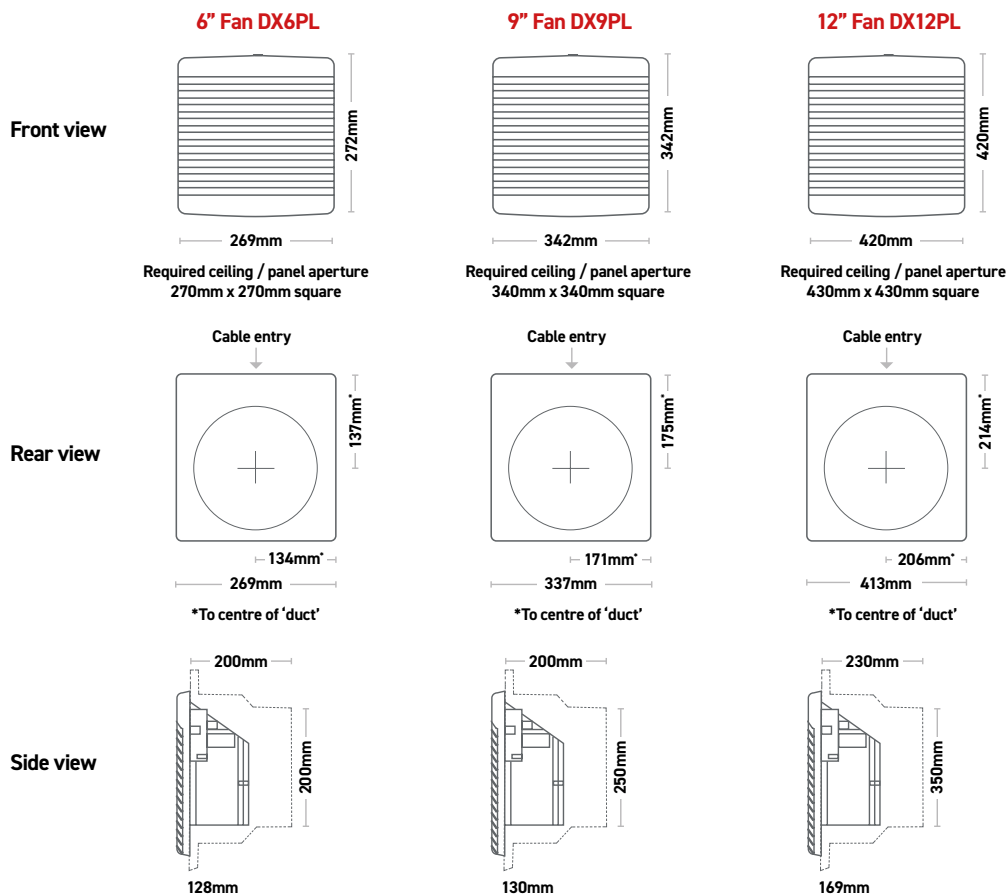

# FAN ANCILLARIES

Unit size	Speed control	Integral sensors			Remote sensors
		PIR	Humidistat	Timer	Humidistat
Description	With Economy 50% setting, extract and supply on/off switch	Passive InfraRed technology to detect movement. Complete with run-on timer 2-40 mins	Relative Humidity setting between 30-90%. Complete with run-on timer 2-40 mins	Run-on timer 2-40 mins	Relative Humidity setting between 30-90%. Complete with run-on timer 2-40 mins
<b>Wall</b>					
6	DX-CON	DX-PIR6	DX-H6	DX-T6	DX-RH
9	DX-CON	DX-PIR9	DX-H9	DX-T9	DX-RH
12	DX-CON	DX-PIR12	DX-H12	DX-T12	DX-RH
<b>Window</b>					
6	DX-CON	DX-PIR6	DX-H6	DX-T6	DX-RH
9	DX-CON	DX-PIR9	DX-H9	DX-T9	DX-RH
12	DX-CON	DX-PIR12	DX-H12	DX-T12	DX-RH
<b>Ceiling</b>					
6	DX-CON	DX-PIR6	DX-H6	DX-T6	DX-RH
9	DX-CON	DX-PIR9	DX-H9	DX-T9	DX-RH
12	DX-CON	DX-PIR12	DX-H12	DX-T12	DX-RH
<b>Flat Roof</b>					
6	DX-CON	DX-PIR6	DX-H6	DX-T6	DX-RH
9	DX-CON	DX-PIR9	DX-H9	DX-T9	DX-RH
12	DX-CON	DX-PIR12	DX-H12	DX-T12	DX-RH
<b>Pitch Roof</b>					
6	DX-CON	DX-PIR6	DX-H6	DX-T6	DX-RH
9	DX-CON	DX-PIR9	DX-H9	DX-T9	DX-RH
12	DX-CON	DX-PIR12	DX-H12	DX-T12	DX-RH

Note:

- ▶ Up to five fans (size 6" / 9") can be controlled by one DX-CON. Up to two fans (size 12") can be controlled by one DX-CON
- ▶ Do not mix different fan sizes on the same controller





								
Basic fan unit	Window spacer	Single spigot adapter	Weather terminal	Roof terminal	Wall fixing plate	Picture frame adapter	DX-WD	DX-LG
Fan module, internal grille	Used for exposed site installation 1 spacer. Use with weather terminals	For ducted systems. To be mounted onto front of DX-WS	For exposed window installations. Use with DX-WS	No fan included	Used for timber and thin walls, pitched roof and above ceiling. One fixing plate. Used with window kits spacers &/or weather terminals	For panel, ceiling or retro installations where uneven walls need to be fixed	Duct wall liner	Fixed blade external louvred grille
<b>Wall cont.</b>								
DX6	DX-WS6	DX-SA6	DX-WT6	N/A	N/A	DX-PF6	DX-WD	DX-LG
DX9	DX-WS9	DX-SA9	DX-WT9	N/A	N/A	DX-PF9	DX-WD	DX-LG
DX12	DX-WS12	DX-SA12	DX-WT12	N/A	N/A	DX-PF12	DX-WD	DX-LG
<b>Window cont.</b>								
DX6	DX-WS6	DX-SA6	DX-WT6	N/A	DX-WP6	N/A	N/A	DX-LG
DX9	DX-WS9	DX-SA9	DX-WT9	N/A	DX-WP9	N/A	N/A	DX-LG
DX12	DX-WS12	DX-SA12	DX-WT12	N/A	DX-WP12	N/A	N/A	DX-LG
<b>Ceiling cont.</b>								
DX6	N/A	DX-SA6	DX-WT6	DX-RT6	DX-WP6	DX-PF6	N/A	N/A
DX9	N/A	DX-SA9	DX-WT9	DX-RT9	DX-WP9	DX-PF9	N/A	N/A
DX12	N/A	DX-SA12	DX-WT12	DX-RT12	DX-WP12	DX-PF12	N/A	N/A
<b>Flat Roof cont.</b>								
DX6	N/A	DX-SA6	N/A	DX-RT6	DX-WP6	DX-PF6	N/A	N/A
DX9	N/A	DX-SA9	N/A	DX-RT9	DX-WP9	DX-PF9	N/A	N/A
DX12	N/A	DX-SA12	N/A	DX-RT12	DX-WP12	DX-PF12	N/A	N/A
<b>Pitch Roof cont.</b>								
DX6	N/A	DX-SA6	DX-WT6	N/A	DX-WP6	DX-PF6	N/A	N/A
DX9	N/A	DX-SA9	DX-WT9	N/A	DX-WP9	DX-PF9	N/A	N/A
DX12	N/A	DX-SA12	DX-WT12	N/A	DX-WP12	DX-PF12	N/A	N/A

# D SERIES CONTROLS



## Multi-fan control

### Fitting Remote Controller DX-CON or Remote Sensors (optional)

The DX-CON Multi-Fan Control provides supply or extract, variable speed and automatic or manual switching of several fans if desired.

The DX-CON should be positioned at least 1.5m above the floor and away from direct heat sources e.g. radiators.

#### NOTE:

- ▶ Up to five fans (size 6"/9") can be controlled by one DX-CON
- ▶ Up to two fans (size 12") can be controlled by one DX-CON
- ▶ Do not mix different fan sizes on the same controller

Code	Description	Length (mm)	Depth (mm)	Height (mm)
DX-CON	Multi-Fan Remote Control	153	60	87

**Speed Control** – with 'Economy' (50%) setting, extract and supply, on/off switches.

### Typical code: DX-CON

#### NOTE:

If two 12" fans or five 6"/9" fans are used in the same operating mode in the same room they should all be controlled from the same DX-CON speed control. This avoids the possibility of one fan (if speed controlled at a lower flow rate) being stalled by the other fan(s). Adequate make-up air provision sufficient to provide ventilation in accordance with building regulations is required in all rooms. This should be checked during commissioning with all fans in the same room running together in all possible configurations.

The automatic shutters, motor bearings should be frequently inspected and maintained to ensure they open fully/operate satisfactorily.

Use of an RCD and fused spur with 1A, Bussmann TDC180, BS1362, fuse (Farnell order no: 1123029) for 1 fan or 2A, Bussmann TDC180, BS1362 fuse (Farnell order no: 1123032) for two or three fans is recommended. Always confirm airflow direction before commissioning.

## Integral sensors

Fan size	PIR	Humidistat	Timer
6	DX-PIR6	DX-H6	DX-T6
9	DX-PIR9	DX-H9	DX-T9
12	DX-PIR12	DX-H12	DX-T12



## Remote sensors

Fan size	Humidistat
6	DX-RH
9	DX-RH
12	DX-RH

The DX-RH remote humidity sensor should be positioned at least 1.5m above the floor and away from direct heat sources e.g. radiators.



# WIRING

## Fan operated by On/Off switch

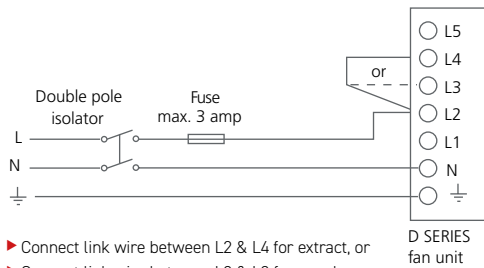

- ▶ Connect link wire between L2 & L4 for extract, or
- ▶ Connect link wire between L2 & L3 for supply

## Basic fan operated by Remote Sensor

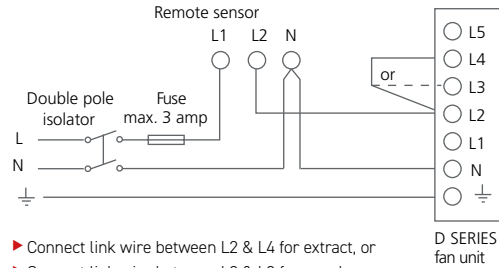

- ▶ Connect link wire between L2 & L4 for extract, or
- ▶ Connect link wire between L2 & L3 for supply

## Fan operated by Integral Sensor

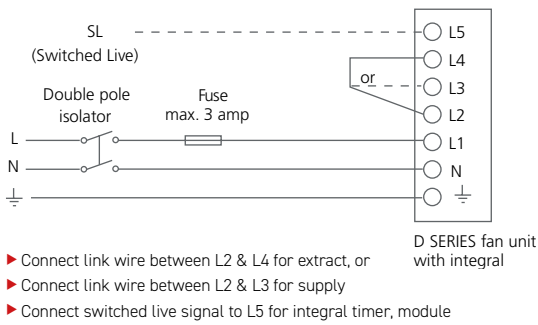

- ▶ Connect link wire between L2 & L4 for extract, or
- ▶ Connect link wire between L2 & L3 for supply
- ▶ Connect switched live signal to L5 for integral timer, module

## Supply / extract fan operated via Remote DX-CON Control

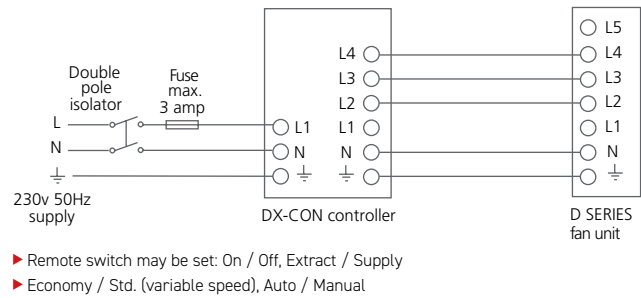

- ▶ Remote switch may be set: On / Off, Extract / Supply
- ▶ Economy / Std. (variable speed), Auto / Manual

## Supply / extract fan operated via Remote DX-CON Control & Remote Sensor(s)

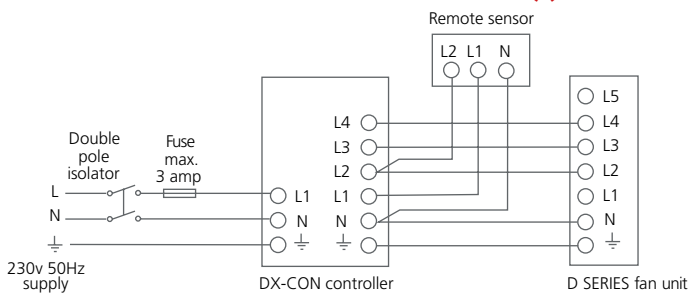

- ▶ Remote switch may be set: On / Off, Extract / Supply, Economy / Std. (variable speed), Auto / Manual
  - ▶ One or more Remote Sensors may be wired in parallel to one DX-CON Control
- Note: Multi-fan options:**
- ▶ Up to five fans (size 6" / 9") can be controlled by one DX-CON. Up to two fans (size 12") can be controlled by one DX-CON. Do not mix different fan sizes on the same controller

## Supply / extract fan operated via Remote DX-CON Control and Integral Sensor

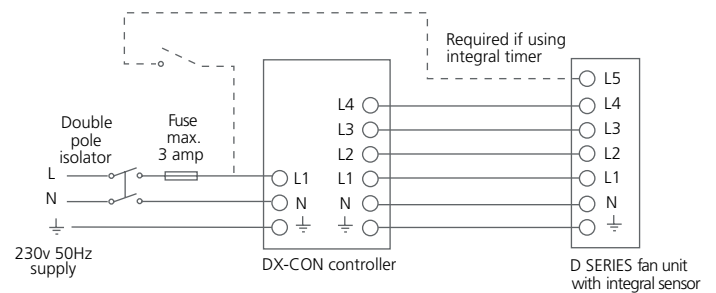

- ▶ Remote switch may be set: On / Off, Extract / Supply, Economy / Std. (variable speed), Auto / Manual
- ▶ Maximum one Integral Sensor per fan 6/9/12 denotes unit size identity
- ▶ Humidity Sensor: DX-H6/9/12
- ▶ Passive Infra Red Sensor: DX-PIR6/9/12
- ▶ Run on Timer: DX-T6/9/12
- ▶ A single sensor will switch all fans if more than one fan is being operated by a single DX-CON controller

# WIRING — MULTIPLE FANS

## Multiple fans operated via remote DX-CON control

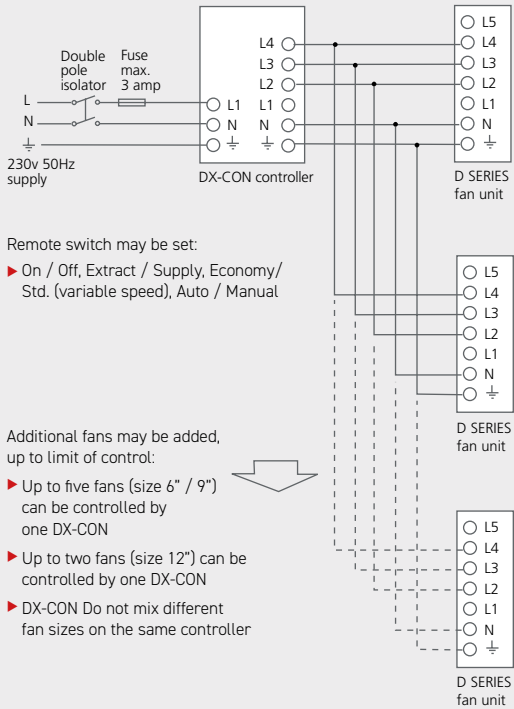

## Multiple fans operated via remote DX-CON control and one Integral Sensor in Fan 1

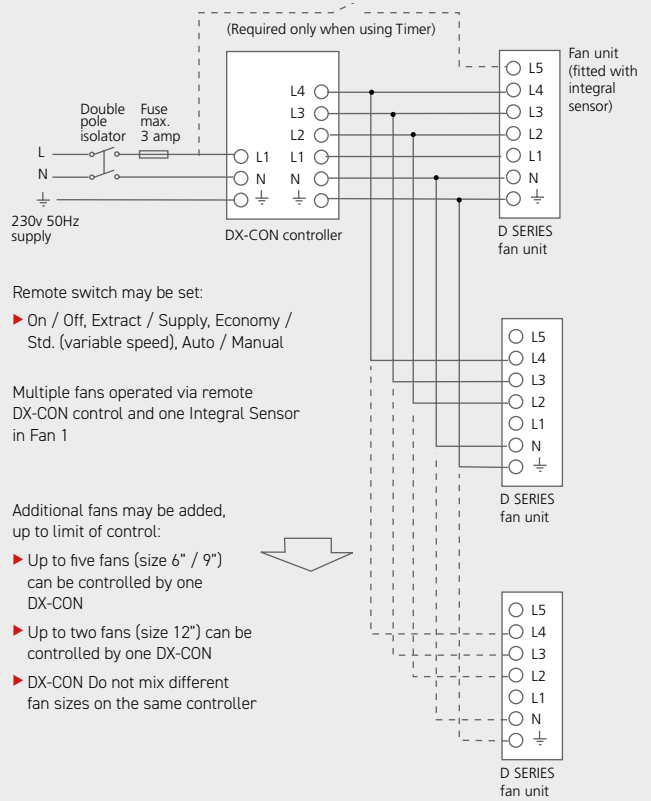

## Multiple fans operated via remote DX-CON control and a Remote Sensor

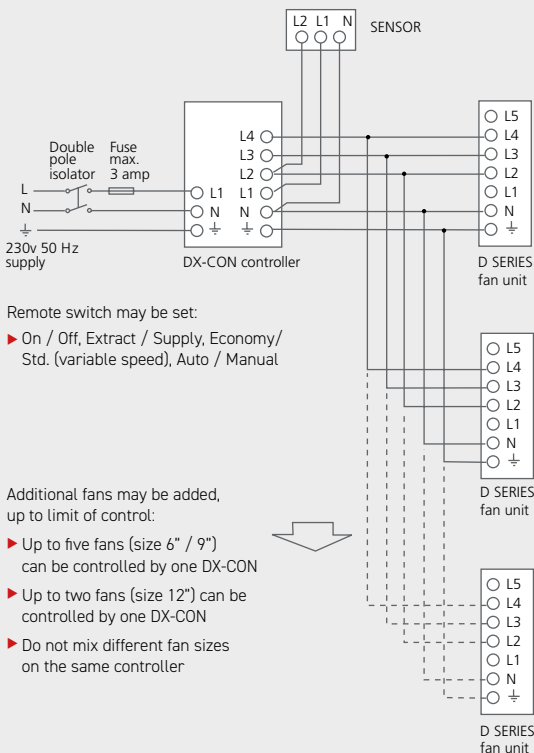

## Fan operated using remote DX-CON control and a Multiple Remote Sensor

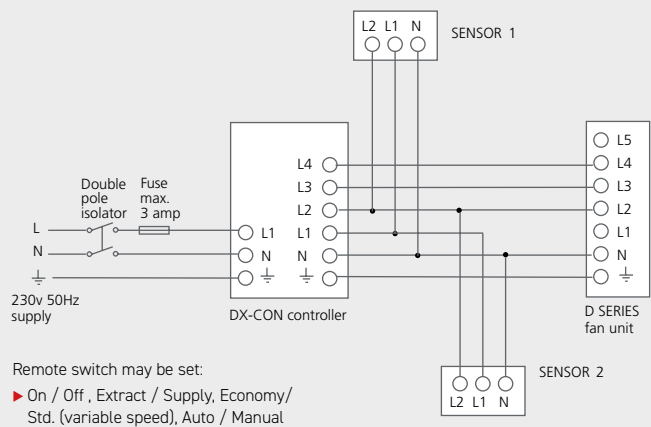

# CONSULTANT SPECIFICATION

## Fan description

Fans shall be located in the positions indicated on the drawings and in accordance with the relevant fan schedule.

The fan shall be of the D SERIES type and shall be supplied complete with integrated low loss radial backdraught shutter, silent operation via a thermo actuator, room side grille, connection kit and external louvre/roof cowl to suit the particular application.

The high efficiency, low noise axial flow impeller shall be directly driven by an external rotor motor featuring enclosure protection to IP 44, class B winding insulation and maintenance free ball bearings.

All models shall be suitable for air over motor temperatures of up to 60°C and 95% R.H (non-condensing). The motor and impeller shall be dynamically balanced as an assembly.

Fan casing, impeller and shutter shall be manufactured from UV stabilised ABS polymer. All models shall include an economy/high efficiency setting facility and are dove grey in colour.

The fan shall be provided complete with integrated or remote controls as detailed in the schedule and as described below.

Where indicated the fans shall be interlinked and controlled from 1No. DX-CON (up to five fans in sizes 6 & 9, up to two fans size 12).

Fans shall be reversible via reversing switch on DX-CON fan controller.

Fan to have a manufacturer's 2 year warranty.

Fan to be of the D SERIES type as manufactured by Domus Ventilation.

## Fan control option

The fan shall be provided with either an integrated sensor to activate the fan, or one of the remote options.

### Integrated control options:

- ▶ DX-T(size) Run-on timer, adjustable between 2-40 minutes
- ▶ DX-H(size) Humidity sensor (30-90%). Includes run-on timer 2-40 minutes
- ▶ DX-PIR(size) PIR sensor, includes run-on timer 2-40 minutes

### Remote control options:

- ▶ DX-RH Humidity sensor 30-90%. Includes run-on timer 2-40 minutes
- ▶ Anti-tamper security strap
- ▶ DX-CON controller incorporating economy switch, reversing switch and rotary speed control

Where indicated the fans shall be interlinked and controlled from 1No. DX-CON (up to five fans in sizes 6 & 9, up to two fans size 12)

Do not mix different fan sizes with same controller

Fan, integrated controls or associated sensors/controllers shall be as manufactured by Domus Ventilation, all with a 2 year warranty

The manufacturer's recommendations should be observed at all times

# ▶ RIGID DUCTING

As a branch based system, rigid duct is ideal for new-build or for where space isn't restricted and can be used with MVHR, MEV, dMEV or intermittent extract.



## Key features

- ▶ Available in six different profiles to suit any application.
- ▶ Comes with a full set of adapters to enable a simple or complex system.
- ▶ High levels of air tightness and system efficiency.
- ▶ Supported by patented duct insulation, fire stopping and sound attenuation components.
- ▶ Range includes high efficiency duct bends, designed to reduce duct resistance and overall system energy usage.
- ▶ Material flammability Class UL-94HB on fittings and UL-94V-0 on Ducting.

## Profile selector & application

Appliance duct connection size					
<b>100mm (4")</b>		<b>125mm (5")</b>		<b>150mm (6")</b>	
What depth is available for the duct?		What depth is available for the duct?		What depth is available for the duct?	
60-105mm	105mm+	65-130mm	130mm+	97-155mm	155mm+
110x54mm	∅100mm	204x60mm	∅125mm	220x90mm	∅150mm

When a profile has been specified and the duct layout designed, the system resistance must be calculated to ensure that the appliance has sufficient power to more than match the resistance of the complete system.

Product	Size	Range	Free Area	Operating Temp
<b>Rectangular</b>				
	110x54mm	System 100	5,300mm <sup>2</sup>	-15° - 60°
	204x60mm	Supertube	11,200mm <sup>2</sup>	-15° - 60°
	220x90mm	Megaduct	17,968mm <sup>2</sup>	-15° - 60°
<b>Round</b>				
	∅100mm	EasiPipe 100	7,850mm <sup>2</sup>	-15° - 60°
	∅125mm	EasiPipe 125	12,266mm <sup>2</sup>	-15° - 60°
	∅150mm	EasiPipe 150	17,263mm <sup>2</sup>	-15° - 60°



Where components are listed with one of three connection profiles; Male, Female or Duct.



**Male:**  
The fitting will fit inside duct.



**Female:**  
The fitting will fit around duct.



**Duct:**  
The connection profile is the same as the duct and may need a Female or Male straight connector to couple to duct.

**NOTE.** UL94 is now harmonised with BS EN 60695-11-10. So either UL94-V0 or Class V0 to BS EN 60695-11-10 would be equivalent.

# ▶ GREEN LINE DUCT BENDS®

Engineered to significantly reduce duct resistance, lower system noise and overall energy usage. Domus Green Line bends are an innovative solution for a well designed and energy efficient duct system.



The colour of the internal vanes as shown in the image is illustrative (manufactured in white).

## Key features & benefits

- ▶ Smoothly channels air through the duct bend in a uniform flow
- ▶ Performance has been tested by the Building Research Establishment (BRE)
- ▶ Reduces duct resistance by up to 60% to lower the system's pressure drop and overall energy usage
- ▶ Reduced air speed through the bend to lower system noise



## Why they are needed:

Owing to the profile of a duct bend, air travelling through it can become turbulent, causing increased resistance and system noise. As a consequence, the mechanical ventilation appliance will need to work harder in order to meet the required air flow rates; therefore, consuming more energy.

Domus Ventilation Green Line high efficiency 90° duct bends have been specifically designed to enable a uniform flow of air through the section of duct, reducing the duct resistance by up to 60% and lowering the air speed. All of which results in a quieter and more efficient ventilation system.

Performance has been tested by the Building Research Establishment (BRE).



## Performance

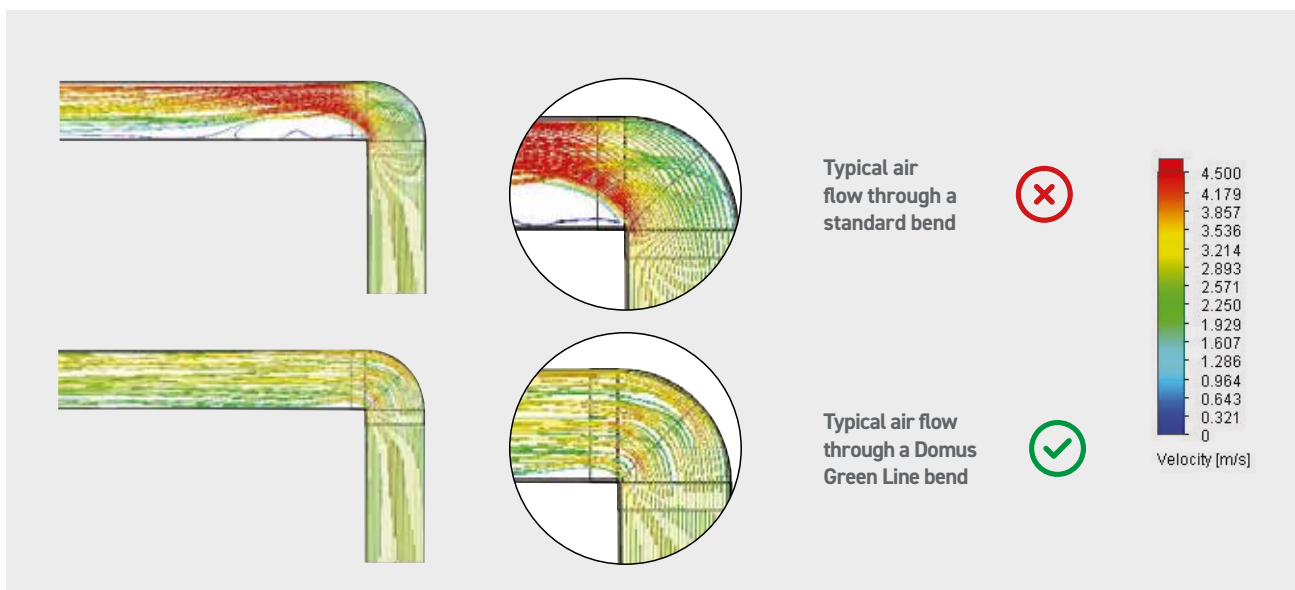

## RIGID DUCTING | RECTANGULAR

All performance data has been taken from BRE Test Report PR0393-1004:2015.

### Duct - 1m

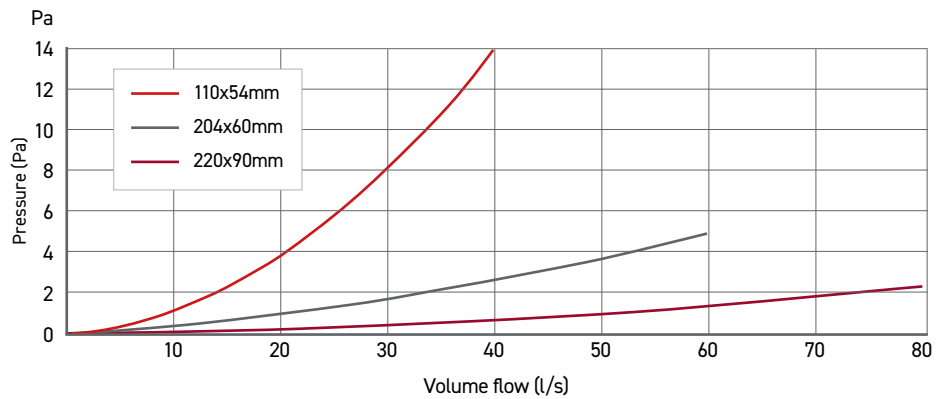

#### 110x54mm System



Free area  
5,300mm<sup>2</sup>

#### 204x60mm System

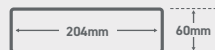

Free area  
11,200mm<sup>2</sup>

#### 220x90mm System

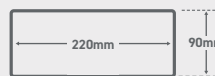

Free area  
17,968mm<sup>2</sup>

#### Resistance data in Pascals (Pa)

Size	@5l/s	@10l/s	@15l/s	@20l/s	@25l/s	@30l/s	@35l/s	@40l/s	@50l/s	@60l/s	@70l/s	@80l/s
110x54mm	0.3	1	2.1	3.7	5.5	8.3	10.2	13.5	-	-	-	-
204x60mm	-	0.3	-	0.9	-	1.6	-	2.6	3.7	4.7	-	-
220x90mm	-	-	-	0.3	-	0.3	-	0.5	1.1	1.4	1.6	2.3

Code	Duct Size	Description	Connection	Material	Colour
DD010	110x54mm	1m straight length of ducting	Duct	Extruded uPVC	White
510	204x60mm	1m straight length of ducting	Duct	Extruded uPVC	White
910	220x90mm	1m straight length of ducting	Duct	Extruded uPVC	White

### Duct - 1.5m



#### 110x54mm System

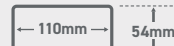

#### 204x60mm System



#### 220x90mm System

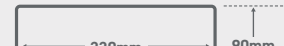

Code	Duct Size	Description	Connection	Material	Colour
DD015	110x54mm	1.5m straight length of ducting	Duct	Extruded uPVC	White
515	204x60mm	1.5m straight length of ducting	Duct	Extruded uPVC	White
915	220x90mm	1.5m straight length of ducting	Duct	Extruded uPVC	White



## RIGID DUCTING | RECTANGULAR

### Duct – 2m

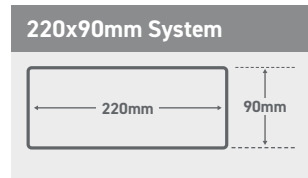
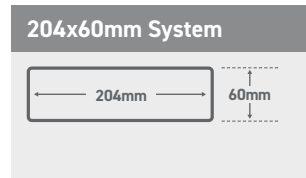
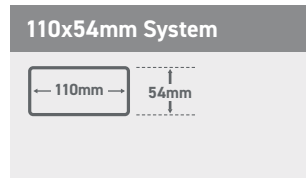

Code	Duct Size	Description	Connection	Material	Colour
D1-2000	110x54mm	2m straight length of ducting	Duct	Extruded uPVC	White
D3-2000	204x60mm	2m straight length of ducting	Duct	Extruded uPVC	White
D4-2000	220x90mm	2m straight length of ducting	Duct	Extruded uPVC	White

### Straight Duct Connector

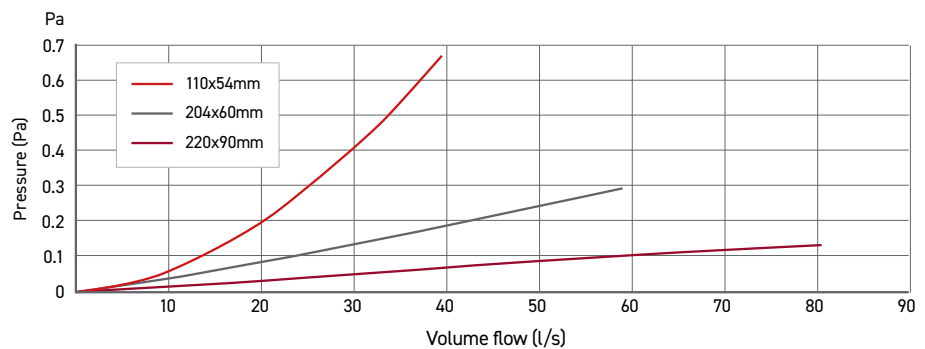

**110x54mm System**

**204x60mm System**

**220x90mm System**

**Resistance data in Pascals (Pa)**

Size	@5l/s	@10l/s	@15l/s	@20l/s	@25l/s	@30l/s	@35l/s	@40l/s	-
110x54mm	0	0	0.2	0.1	0.3	0.2	0.7	0.6	-

Size	@10l/s	@20l/s	@30l/s	@40l/s	@50l/s	@60l/s	@70l/s	@80l/s	@90l/s
204x60mm	0	0	0.2	0.2	0.2	0.3	0.4	0.5	0.3
220x90mm	0	0	0.1	0.1	0	0.1	0.2	0.1	-

Code	Duct Size	Description	Connection	Material	Colour
DD020	110x54mm	Straight Duct Connector	Female	HIPS (High Impact Polystyrene)	White
520	204x60mm	Straight Duct Connector	Female	HIPS (High Impact Polystyrene)	White
920	220x90mm	Straight Duct Connector	Female	HIPS (High Impact Polystyrene)	White

## RIGID DUCTING | RECTANGULAR

### Straight Duct Connector with Damper



#### 110x54mm System



#### 204x60mm System



#### 220x90mm System

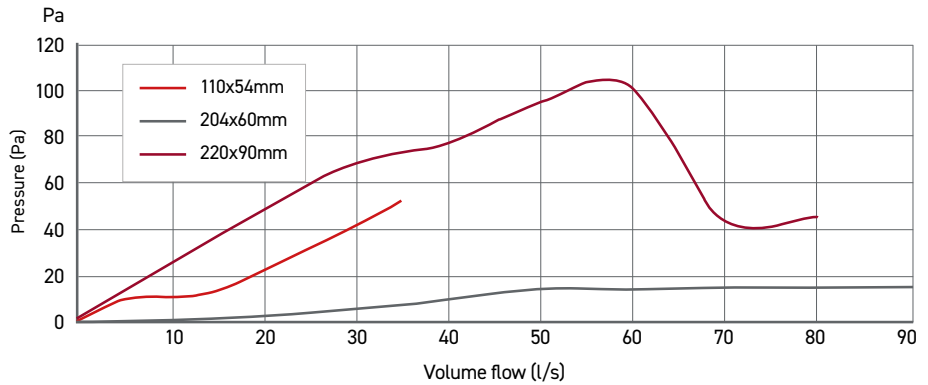

#### Resistance data in Pascals (Pa)

Size	@5l/s	@10l/s	@15l/s	@20l/s	@25l/s	@30l/s	@35l/s	-
110x54mm	9.4	10.6	13.1	21.9	31.4	41	51.7	-

Size	@10l/s	@20l/s	@30l/s	@40l/s	@50l/s	@60l/s	@70l/s	@80l/s	@90l/s
204x60mm	0.8	2.9	6.5	11.1	17.1	16.8	17.7	17.8	18
220x90mm	23.6	47.3	68.6	77.5	94.9	102.1	43.8	44.6	-

Code	Duct Size	Description	Connection	Material	Colour
DD027	110x54mm	Straight Duct Connector with Damper	Female	HIPS (High Impact Polystyrene)	White
527	204x60mm	Straight Duct Connector with Damper	Female	HIPS (High Impact Polystyrene)	White
927	220x90mm	Straight Duct Connector with Damper	Female	HIPS (High Impact Polystyrene)	White

### Universal Duct Connector



#### 204x60mm System

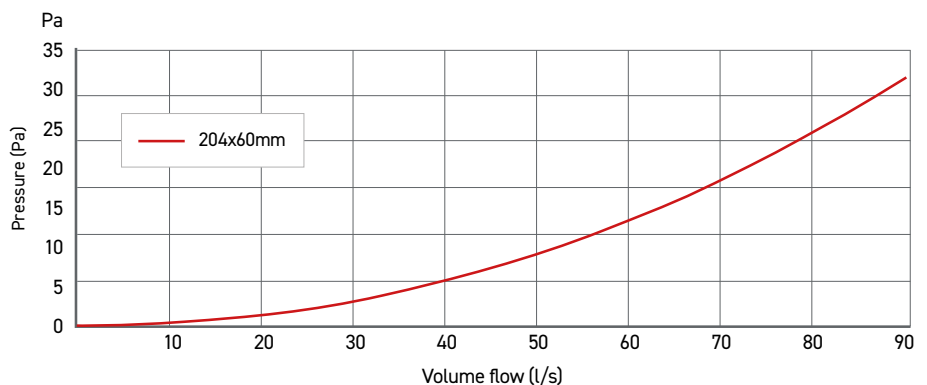

Code	Duct Size	Description	Connection	Material	Colour
5B303	204x60mm	Universal Duct Connector	Male	Santroprene	Black

\* Resistance data in Pascals (Pa)

# RIGID DUCTING | RECTANGULAR

## 90° Horizontal Green Line® High Efficiency Bend

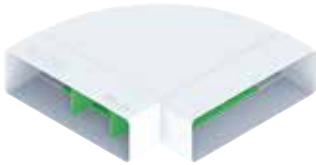

The colour of the internal vanes as shown in the image is illustrative (manufactured in white).

### 204x60mm System



### 220x90mm System

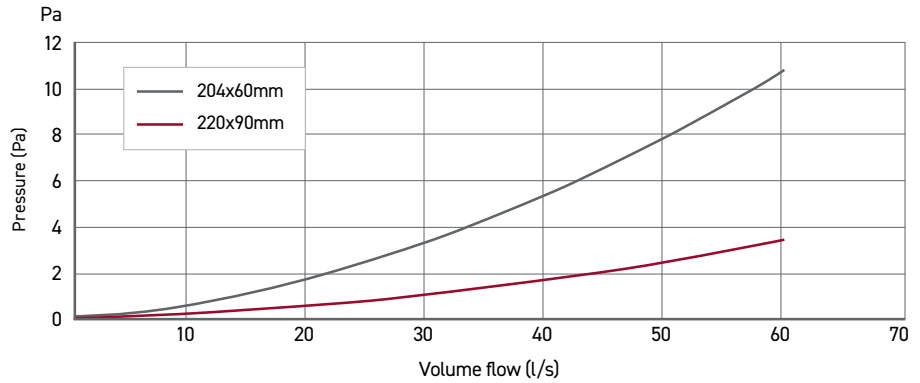

### Resistance data in Pascals (Pa)

Size	@10l/s	@20l/s	@30l/s	@40l/s	@50l/s	@60l/s	@70l/s	@80l/s
204x60mm	0.4	1.5	3.5	5.4	7.5	10.5	-	-
220x90mm	0.2	0.5	1	1.5	2.4	3.3	4.4	5.4

Code	Duct Size	Description	Connection	Material	Colour
550-GL	204x60mm	90° Horizontal Bend High Efficiency	Female	Injection Moulded Hips (High Impact Polystyrene)	White
950-GL	220x90mm	90° Horizontal Bend High Efficiency	Female	Injection Moulded Hips (High Impact Polystyrene)	White

## 90° Horizontal Bend



### 110x54mm System



### 204x60mm System

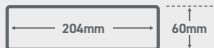

### 220x90mm System

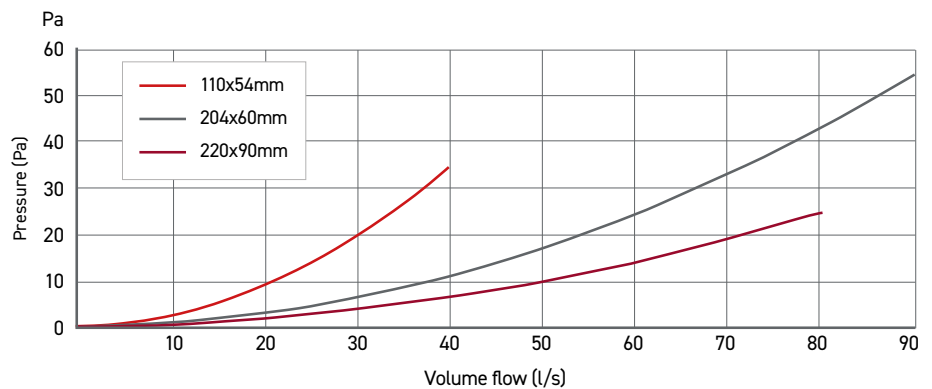
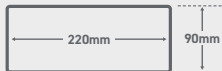

### Resistance data in Pascals (Pa)

Size	@5l/s	@10l/s	@15l/s	@20l/s	@25l/s	@30l/s	@35l/s	@40l/s	-
110x54mm	0.7	2.3	5	8.7	13.4	19.3	26.2	34.3	-
Size	@10l/s	@20l/s	@30l/s	@40l/s	@50l/s	@60l/s	@70l/s	@80l/s	@90l/s
204x60mm	0.8	2.9	6.4	10.9	16.8	23.9	32.7	43.1	54.2
220x90mm	0.3	0.9	2.3	3.5	5.5	7.7	10.7	13.8	-

Code	Duct Size	Description	Connection	Material	Colour
DD050	110x54mm	90° Horizontal Bend	Female	HIPS (High Impact Polystyrene)	White
550	204x60mm	90° Horizontal Bend	Female	HIPS (High Impact Polystyrene)	White
950	220x90mm	90° Horizontal Bend	Female	HIPS (High Impact Polystyrene)	White

## RIGID DUCTING | RECTANGULAR

### 45° Horizontal Bend



**110x54mm System**

**204x60mm System**

**220x90mm System**

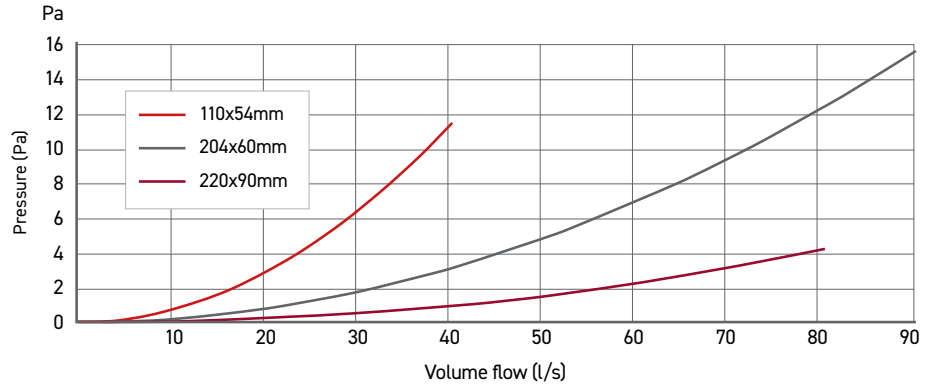

Size	@5l/s	@10l/s	@15l/s	@20l/s	@25l/s	@30l/s	@35l/s	@40l/s	-
110x54mm	0.3	0.8	1.6	3	4.6	6.5	9	11.6	-
Size	@10l/s	@20l/s	@30l/s	@40l/s	@50l/s	@60l/s	@70l/s	@80l/s	@90l/s
204x60mm	0.3	0.8	1.9	3.1	4.9	7.1	9.6	12.6	15.7
220x90mm	0.1	0.3	0.6	1	1.6	2.3	3.3	4.3	-

Code	Duct Size	Description	Connection	Material	Colour
DD055	110x54mm	45° Horizontal Bend	Female	HIPS (High Impact Polystyrene)	White
555	204x60mm	45° Horizontal Bend	Female	HIPS (High Impact Polystyrene)	White
955	220x90mm	45° Horizontal Bend	Female	HIPS (High Impact Polystyrene)	White

### Horizontal T Piece



**110x54mm System**

**204x60mm System**

**220x90mm System**

Code	Duct Size	Description	Connection	Material	Colour
DD080	110x54mm	Horizontal T Piece	Female	HIPS (High Impact Polystyrene)	White
582	204x60mm	Horizontal T Piece	Female	HIPS (High Impact Polystyrene)	White
982	220x90mm	Horizontal T Piece	Female	HIPS (High Impact Polystyrene)	White

For further information, please contact our Design Team at [vent.projects@domusventilation.co.uk](mailto:vent.projects@domusventilation.co.uk)

# RIGID DUCTING | RECTANGULAR

## 90° Vertical Bend



**110x54mm System**

**204x60mm System**

**220x90mm System**

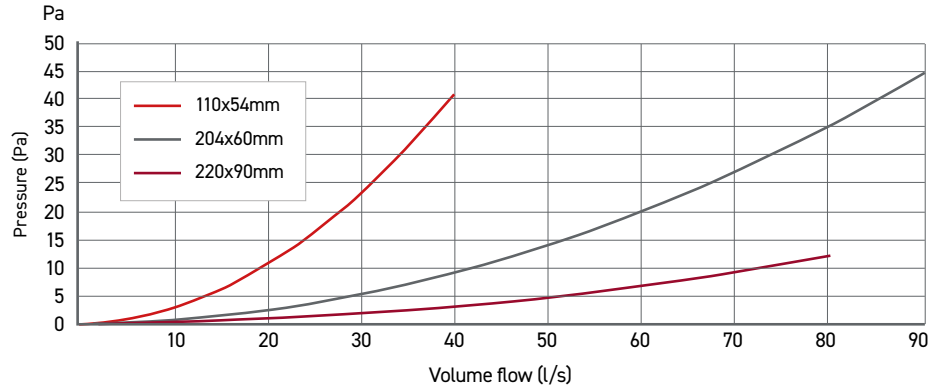

Resistance data in Pascals (Pa)													
Size	@5l/s	@10l/s	@15l/s	@20l/s	@25l/s	@30l/s	@35l/s	@40l/s	@50l/s	@60l/s	@70l/s	@80l/s	@90l/s
110x54mm	0.8	2.5	5.8	10.6	15.6	22.7	31.3	40.2	-	-	-	-	-
204x60mm	-	0.7	-	2.4	-	5.2	-	8.9	13.9	19.7	26.7	35.4	44.1
220x90mm	-	0.3	-	0.9	-	1.8	-	3.1	4.6	6.6	9.2	11.9	-

Code	Duct Size	Description	Connection	Material	Colour
DD060	110x54mm	90° Vertical Bend	Female	HIPS (High Impact Polystyrene)	White
560	204x60mm	90° Vertical Bend	Female	HIPS (High Impact Polystyrene)	White
960	220x90mm	90° Vertical Bend	Female	HIPS (High Impact Polystyrene)	White

## 45° Vertical Bend



**110x54mm System**

**204x60mm System**

**220x90mm System**

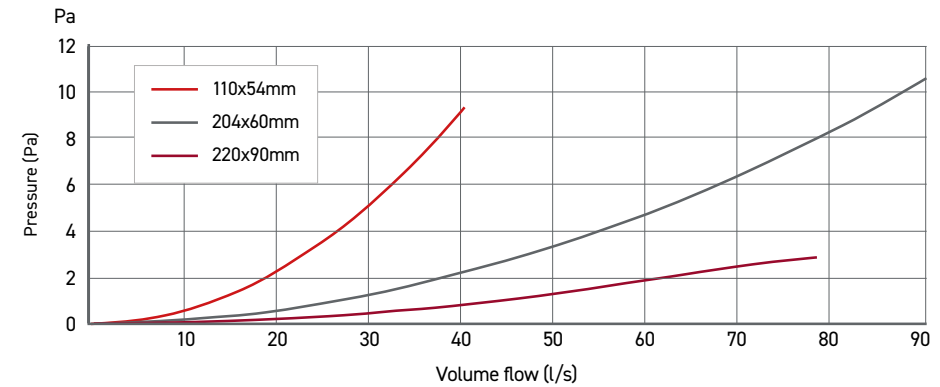





Resistance data in Pascals (Pa)										
Size	@5l/s	@10l/s	@15l/s	@20l/s	@25l/s	@30l/s	@35l/s	@40l/s	-	-
110x54mm	0.2	0.5	1.3	2.4	3.6	5	7	9.4	-	-
Size	@10l/s	@20l/s	@30l/s	@40l/s	@50l/s	@60l/s	@70l/s	@80l/s	@90l/s	-
204x60mm	0.2	0.6	1.3	2.2	3.3	4.7	6.4	8.3	10.5	-
220x90mm	0.1	0.2	0.5	0.8	1.3	1.9	2.5	3	-	-

Code	Duct Size	Description	Connection	Material	Colour
DD075	110x54mm	45° Vertical Bend	Female	HIPS (High Impact Polystyrene)	White
575	204x60mm	45° Vertical Bend	Female	HIPS (High Impact Polystyrene)	White
975	220x90mm	45° Vertical Bend	Female	HIPS (High Impact Polystyrene)	White

## RIGID DUCTING | RECTANGULAR









### End Caps

Domus Ventilation End Caps provide a quick and easy way of terminating a duct run with an air tight seal.

System	Product	Code	Description	Connection	Material	Colour	System
<b>110x54mm System</b> 		DD018	Rigid Duct End cap	Male	HIPS (High Impact Polystyrene)	White	110x54mm
<b>204x60mm System</b> 		518	Rigid Duct End cap	Male	HIPS (High Impact Polystyrene)	White	204x60mm







### Wall Plates

For installation between the duct run and external terminal, these wall plates are a simple way to ensure the duct is securely supported and held in place.

System	Product	Code	Description	Material	Colour	System
<b>110x54mm System</b> 		115-4	Rigid Duct Wall Plate	HIPS (High Impact Polystyrene)	White	110x54mm
<b>204x60mm System</b> 		115-5W	Rigid Duct Wall Plate	HIPS (High Impact Polystyrene)	White	204x60mm
		115-5B	Rigid Duct Wall Plate	HIPS (High Impact Polystyrene)	Brown	204x60mm
<b>220x90mm System</b> 		115-5C	Rigid Duct Wall Plate	HIPS (High Impact Polystyrene)	Cotswold	204x60mm
		115-5T	Rigid Duct Wall Plate	HIPS (High Impact Polystyrene)	Terracotta	204x60mm
		115-6	Rigid Duct Wall Plate	HIPS (High Impact Polystyrene)	White	220x90mm

### Duct Clips

Duct clips are an effective part of the overall duct system and quick and easy to fasten into place. Domus Ventilation Duct Clips securely hold duct runs and prevent them from bowing.

System	Product	Code	Description	Material	Colour	System
<b>110x54mm System</b> 		122-4	Rigid Duct Clip	HIPS (High Impact Polystyrene)	White	110x54mm
<b>204x60mm System</b> 		522*	Rigid Duct Clip	HIPS (High Impact Polystyrene)	White	204x60mm
<b>220x90mm System</b> 		922*	Rigid Duct Clip	HIPS (High Impact Polystyrene)	White	220x90mm

\*Two components per fitting point

## RIGID DUCTING | ROUND

Domus rigid duct is manufactured from exacting tolerances to virtually eliminate air leakage and reduce pressure drop.

Domus EasiPipe 100 is suitable for Bathroom, Toilet and Utility room applications

### Ø100mm EasyPipe 100



Free Area 7,850mm<sup>2</sup>

### Ø125mm EasyPipe 125



Free Area 12,266mm<sup>2</sup>

### Ø150mm EasyPipe 150



Free Area 17,263mm<sup>2</sup>

### Telescopic Assembly Duct – 0.25-0.45m



Code	Duct Size	Connection	Material	Colour
130-4	Ø100mm	Duct	Extruded uPVC	White
130-5	Ø125mm	Duct	Extruded uPVC	White
130-6	Ø150mm	Duct	Extruded uPVC	White

### Duct – 0.35m Straight Length of Ducting



Code	Duct Size	Connection	Material	Colour
135-4	Ø100mm	Duct	Extruded uPVC	White
135-5	Ø125mm	Duct	Extruded uPVC	White
135-6	Ø150mm	Duct	Extruded uPVC	White

### Duct – 1m Straight Length of Ducting



#### Ø100mm EasyPipe 100

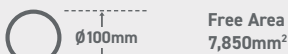

Free Area 7,850mm<sup>2</sup>

#### Ø125mm EasyPipe 125



Free Area 12,266mm<sup>2</sup>

#### Ø150mm EasyPipe 150



Free Area 17,263mm<sup>2</sup>

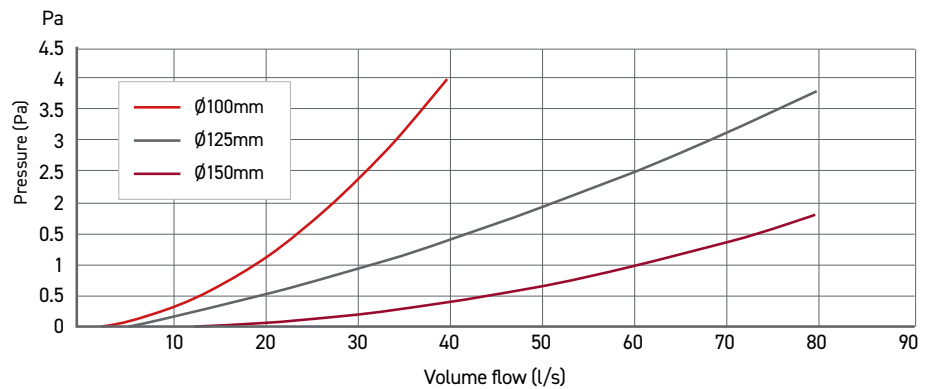

#### Resistance data in Pascals (Pa)

Size	@5l/s	@10l/s	@15l/s	@20l/s	@25l/s	@30l/s	@35l/s	@40l/s
Ø100mm	0.1	0.3	0.6	1.1	1.6	2.4	3.2	3.9
Size	@10l/s	@20l/s	@30l/s	@40l/s	@50l/s	@60l/s	@70l/s	@80l/s
Ø125mm	0.1	0.5	0.8	1.4	2	2.7	3.2	3.7
Ø150mm	0	0.2	0.3	0.3	0.7	1	1.3	1.9

Code	Duct Size	Description	Connection	Material	Colour
1100-4	Ø100mm	1m straight length of ducting	Duct	Extruded uPVC	White
1100-5	Ø125mm	1m straight length of ducting	Duct	Extruded uPVC	White
1100-6	Ø150mm	1m straight length of ducting	Duct	Extruded uPVC	White

## RIGID DUCTING | ROUND

### Duct Sleeve – 1m



Code	Duct Size	Connection	Material	Colour
2100-4	Ø100mm	N/A	Extruded uPVC	White
2100-5	Ø125mm	N/A	Extruded uPVC	White
2100-6	Ø150mm	N/A	Extruded uPVC	White

### Duct – 2m Straight Length of Ducting



Code	Duct Size	Connection	Material	Colour
1200-4	Ø100mm	Duct	Extruded uPVC	White
1200-5	Ø125mm	Duct	Extruded uPVC	White
1200-6	Ø150mm	Duct	Extruded uPVC	White

### Straight Duct Connector



#### Ø100mm EasyPipe 100

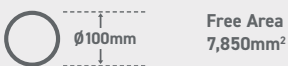

#### Ø125mm EasyPipe 125

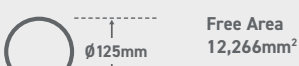

#### Ø150mm EasyPipe 150

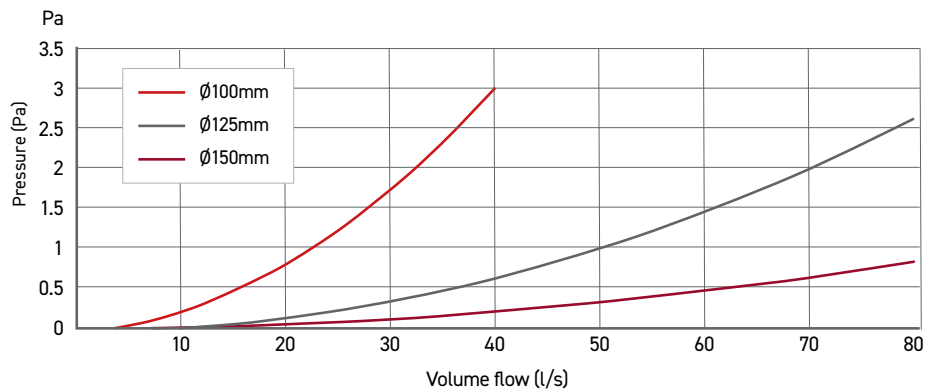

#### Resistance data in Pascals (Pa)

Size	@5l/s	@10l/s	@15l/s	@20l/s	@25l/s	@30l/s	@35l/s	@40l/s
Ø100mm	0	0.2	0.4	0.8	1.3	1.8	2.3	3

Size	@10l/s	@20l/s	@30l/s	@40l/s	@50l/s	@60l/s	@70l/s	@80l/s
Ø125mm	0	0.1	0.3	0.6	1	1.5	2.1	2.5
Ø150mm	0	0.1	0.1	0.2	0.3	0.5	0.7	0.8

Code	Duct Size	Description	Connection	Material	Colour
493	Ø100mm	Straight duct connector	Male	HIPS (High Impact Polystyrene)	White
593	Ø125mm	Straight duct connector	Male	HIPS (High Impact Polystyrene)	White
693	Ø150mm	Straight duct connector	Male	HIPS (High Impact Polystyrene)	White



## RIGID DUCTING | ROUND

### Straight Connector with Damper



#### Ø100mm EasyPipe 100

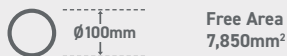

#### Ø125mm EasyPipe 125

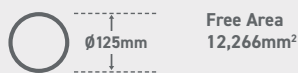

#### Ø150mm EasyPipe 150

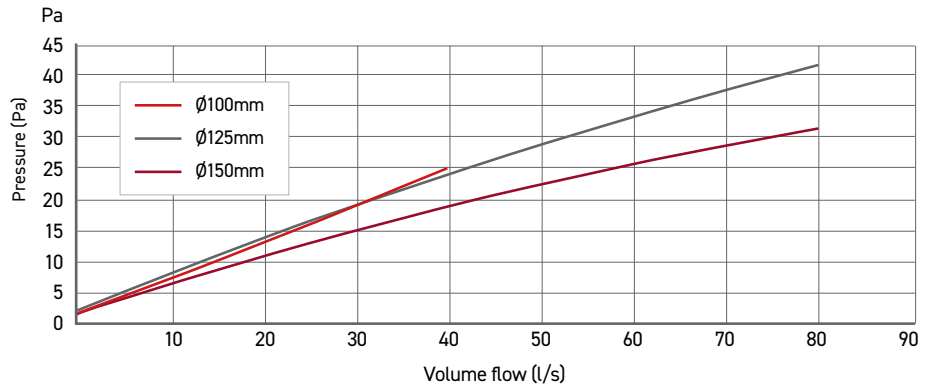

#### Resistance data in Pascals (Pa)

Size	@5l/s	@10l/s	@15l/s	@20l/s	@25l/s	@30l/s	@35l/s	@40l/s
Ø100mm	5.5	7.7	9.9	12.1	14.8	18	20.8	24.9
Size	@10l/s	@20l/s	@30l/s	@40l/s	@50l/s	@60l/s	@70l/s	@80l/s
Ø125mm	10.1	14.5	18.3	23.5	27.5	32.5	38.6	41.3
Ø150mm	7.7	11.5	14.8	18.4	21.4	25	28.9	31.5

Code	Duct Size	Description	Connection	Material	Colour
494	Ø100mm	Straight Connector with Damper	Male	HIPS (High Impact Polystyrene)	White
594	Ø125mm	Straight Connector with Damper	Male	HIPS (High Impact Polystyrene)	White
694	Ø150mm	Straight Connector with Damper	Male	HIPS (High Impact Polystyrene)	White

### Straight Connector with Damper and Wall Plate



#### Ø100mm EasyPipe 100

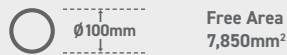

#### Ø125mm EasyPipe 125

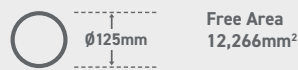

#### Ø150mm EasyPipe 150

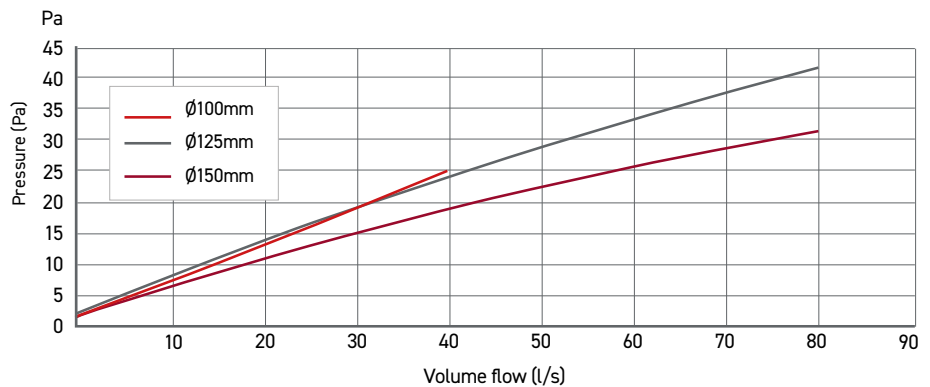

#### Resistance data in Pascals (Pa)



Size	@5l/s	@10l/s	@15l/s	@20l/s	@25l/s	@30l/s	@35l/s	@40l/s
Ø100mm	5.5	7.7	9.9	12.1	14.8	18	20.8	24.9
Size	@10l/s	@20l/s	@30l/s	@40l/s	@50l/s	@60l/s	@70l/s	@80l/s
Ø125mm	10.1	14.5	18.3	23.5	27.5	32.5	38.6	41.3
Ø150mm	7.7	11.5	14.8	18.4	21.4	25	28.9	31.5

Code	Duct Size	Description	Connection	Material	Colour
495	Ø100mm	Straight Connector with Damper and Wall Plate	Male	HIPS (High Impact Polystyrene)	White
595	Ø125mm	Straight Connector with Damper and Wall Plate	Male	HIPS (High Impact Polystyrene)	White
695	Ø150mm	Straight Connector with Damper and Wall Plate	Male	HIPS (High Impact Polystyrene)	White

## RIGID DUCTING | ROUND

### 90° Horizontal Bend



<b>Ø100mm EasyPipe 100</b>	
	Free Area 7,850mm <sup>2</sup>
<b>Ø125mm EasyPipe 125</b>	
	Free Area 12,266mm <sup>2</sup>
<b>Ø150mm EasyPipe 150</b>	
	Free Area 17,263mm <sup>2</sup>

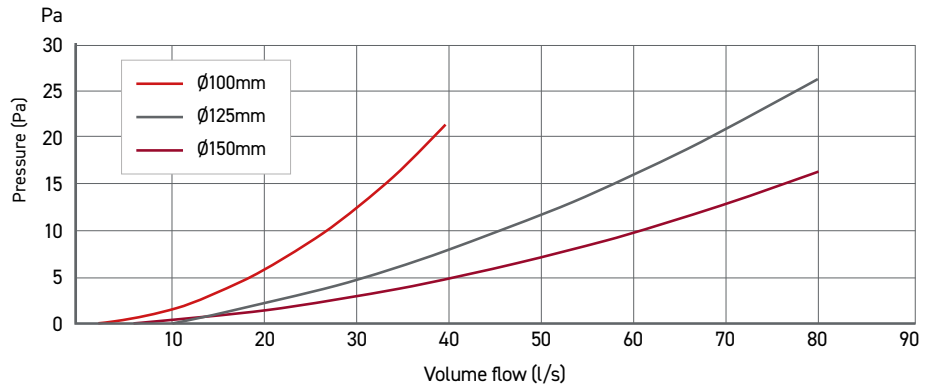

Resistance data in Pascals (Pa)



Size	@5l/s	@10l/s	@15l/s	@20l/s	@25l/s	@30l/s	@35l/s	@40l/s
Ø100mm	0.4	1.3	3	5.3	8.6	12.2	16	20.8

Size	@10l/s	@20l/s	@30l/s	@40l/s	@50l/s	@60l/s	@70l/s	@80l/s
Ø125mm	0.5	1.8	3.9	7.6	11.3	16.2	21	25
Ø150mm	0.3	1.2	2.5	4.6	7.2	9.9	13.2	15.4

Code	Duct Size	Description	Connection	Material	Colour
490	Ø100mm	Rigid Duct 90° Horizontal Bend	Male	HIPS (High Impact Polystyrene)	White
590	Ø125mm	Rigid Duct 90° Horizontal Bend	Male	HIPS (High Impact Polystyrene)	White
690	Ø150mm	Rigid Duct 90° Horizontal Bend	Male	HIPS (High Impact Polystyrene)	White

### 45° Horizontal Bend



<b>Ø100mm EasyPipe 100</b>	
	Free Area 7,850mm <sup>2</sup>
<b>Ø125mm EasyPipe 125</b>	
	Free Area 12,266mm <sup>2</sup>
<b>Ø150mm EasyPipe 150</b>	
	Free Area 17,263mm <sup>2</sup>

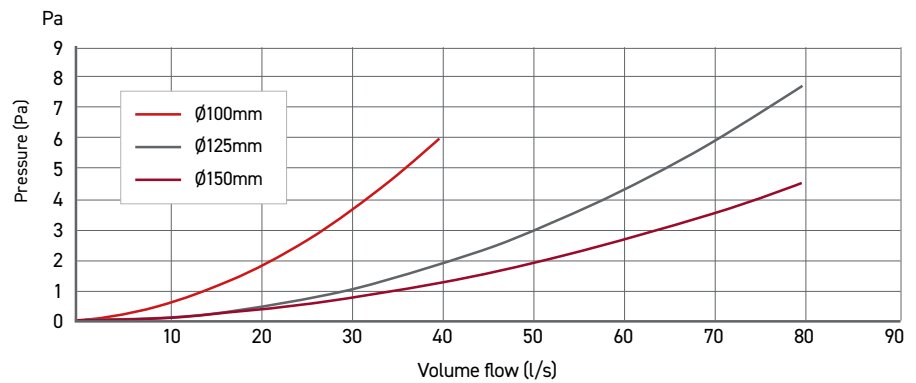

Resistance data in Pascals (Pa)

Size	@5l/s	@10l/s	@15l/s	@20l/s	@25l/s	@30l/s	@35l/s	@40l/s
Ø100mm	0.2	0.5	1.1	1.7	2.4	3.7	4.7	5.9

Size	@10l/s	@20l/s	@30l/s	@40l/s	@50l/s	@60l/s	@70l/s	@80l/s
Ø125mm	0.1	0.4	1	1.9	2.9	4.2	5.8	7.8
Ø150mm	0.1	0.3	0.7	1.1	1.9	2.8	3.6	4.4

Code	Duct Size	Description	Connection	Material	Colour
491	Ø100mm	Rigid Duct 45° Horizontal Bend	Male	HIPS (High Impact Polystyrene)	White
591	Ø125mm	Rigid Duct 45° Horizontal Bend	Male	HIPS (High Impact Polystyrene)	White
691	Ø150mm	Rigid Duct 45° Horizontal Bend	Male	HIPS (High Impact Polystyrene)	White

# RIGID DUCTING | ROUND

## Horizontal T Piece



**Ø100mm  
EasyPipe 100**

Free Area 7,850mm<sup>2</sup>

**Ø125mm  
EasyPipe 125**

Free Area 12,266mm<sup>2</sup>

**Ø150mm  
EasyPipe 150**

Free Area 17,263mm<sup>2</sup>

Code	Duct Size	Description	Connection	Material	Colour
492	Ø100mm	Rigid Duct Horizontal T Piece	Male	HIPS (High Impact Polystyrene)	White
592	Ø125mm	Rigid Duct Horizontal T Piece	Male	HIPS (High Impact Polystyrene)	White
692	Ø150mm	Rigid Duct Horizontal T Piece	Male	HIPS (High Impact Polystyrene)	White

## Y Piece - PVC



**Ø100mm EasyPipe 100**

Free Area 7,850mm<sup>2</sup>

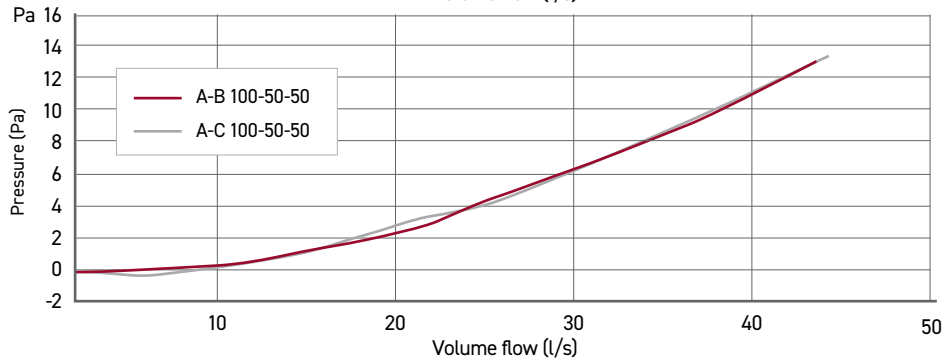
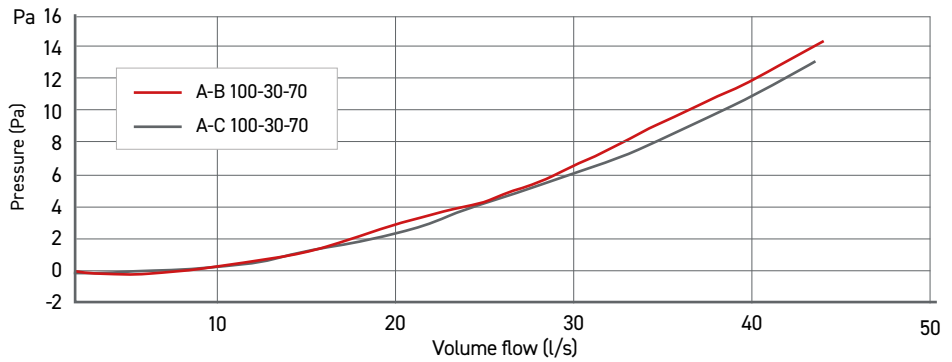



Resistance data in Pascals (Pa)										
	@0l/s	@5l/s	@10l/s	@15l/s	@20l/s	@25l/s	@30l/s	@35l/s	@40l/s	@45l/s
A-B 100-30-70	-0.1	-0.2	0.4	1.4	3.1	4.5	6.7	9.4	11.9	14.8
A-C 100-30-70	-0.1	-0.3	0.4	1.5	3.1	4.4	6.5	8.8	11.3	13.8
A-B 100-50-50	-0.1	0.0	0.4	1.4	2.5	4.5	6.4	8.2	10.7	13.4
A-C 100-50-50	-0.1	0.0	0.4	1.4	2.5	4.5	6.4	8.4	10.7	13.4

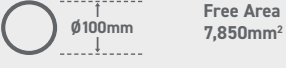
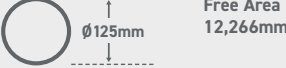

Code	Duct Size	Description	Connection	Material	Colour
499	Ø100mm	Rigid Duct Y Piece	Male	HIPS (High Impact Polystyrene)	White

## RIGID DUCTING | ROUND



### Wall Plates

<b>Ø100mm EasyPipe 100</b>		Free Area 7,850mm <sup>2</sup>
<b>Ø125mm EasyPipe 125</b>		Free Area 12,266mm <sup>2</sup>
<b>Ø150mm EasyPipe 150</b>		Free Area 17,263mm <sup>2</sup>

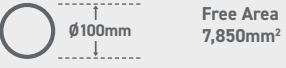

For installation between the duct run and external terminal, these wall plates are a simple way to ensure the duct is securely supported and held in place.

Product	Code	Description	Material	Colour	System
	114-4	Rigid Duct Wall Plate	HIPS (High Impact Polystyrene)	White	Ø100mm
	114-5	Rigid Duct Wall Plate	HIPS (High Impact Polystyrene)	White	Ø125mm
	114-6	Rigid Duct Wall Plate	HIPS (High Impact Polystyrene)	White	Ø150mm

### Duct Clips

<b>Ø100mm EasyPipe 100</b>		Free Area 7,850mm <sup>2</sup>
<b>Ø125mm EasyPipe 125</b>		Free Area 12,266mm <sup>2</sup>
<b>Ø150mm EasyPipe 150</b>		Free Area 17,263mm <sup>2</sup>

100 / 125 and 150mm duct size clips are an effective part of the overall duct system and quick and easy to fasten into place, Domus Duct Clips securely hold duct runs and prevent them from bowing.

Product	Code	Description	Material	Colour	System
	496	Rigid Duct Clip - Round	HIPS (High Impact Polystyrene)	White	Ø100mm
	596	Rigid Duct Clip - Round	HIPS (High Impact Polystyrene)	White	Ø125mm
	696	Rigid Duct Clip - Round	HIPS (High Impact Polystyrene)	White	Ø150mm

### Condensation Traps with Overflow Connection

#### Key features

- ▶ Recommended in both the Building Regulations and NHBC Standards
- ▶ Removes condensation risks from unheated areas
- ▶ Real advantages over using insulated hose
- ▶ Simple to install and handle
- ▶ Cost effective solution
- ▶ Specifically designed for ventilation applications

#### Condensation Trap Pipe Combinations

Code: 100mm/110mm

Remove the reducing ring

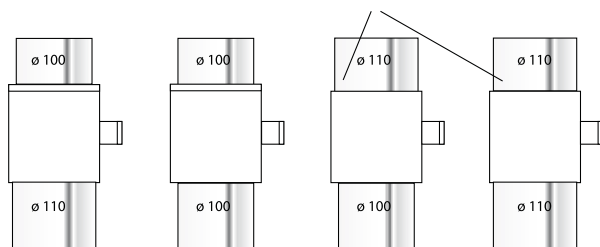

All dimensions shown in mm.

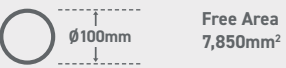
<b>Ø100mm EasyPipe 100</b>		Free Area 7,850mm <sup>2</sup>
----------------------------	---	-----------------------------------

Code	Duct Size	Description	Connection	Material	Colour
497	Ø100mm Ø110mm	Condensation Trap with Overflow Connection	Male/ Female	HIPS (High Impact Polystyrene)	White

## RIGID DUCTING | IN-LINE ADAPTER

### In-line Adapter, Rectangular to Round (110x54 - Ø100mm)



110x54 - Ø100mm

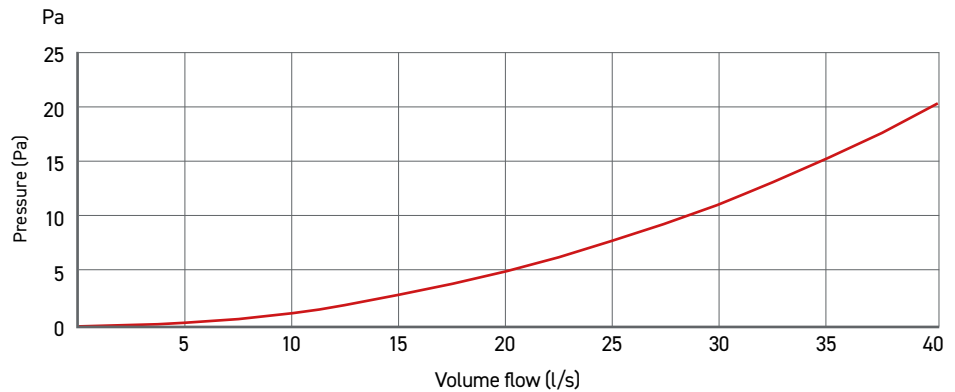

Resistance data in Pascals (Pa)							
@5l/s	@10l/s	@15l/s	@20l/s	@25l/s	@30l/s	@35l/s	@40l/s
0.3	1.3	3.0	5.2	8.0	11.4	15.9	20.6

Code	Size (mm)		Description	Connection	Material	Colour
	From	To				
DD070	110x54	Ø100	In-line Adapter Rectangular - Round	Female/Duct	PVC	White

### In-line Adapter, Rectangular to Round (204x60 - Ø100mm)



204x60 - Ø100mm

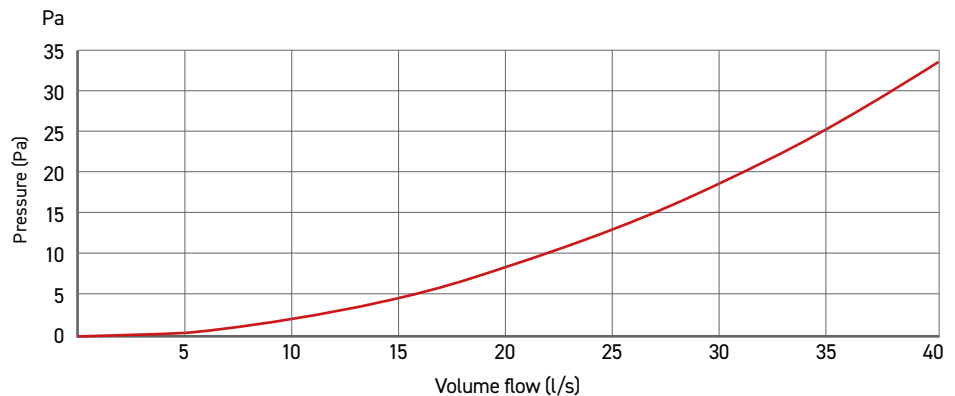

Resistance data in Pascals (Pa)							
@5l/s	@10l/s	@15l/s	@20l/s	@25l/s	@30l/s	@35l/s	@40l/s
0.5	2.2	4.8	8.6	13.4	18.9	25.8	33.9

Code	Size (mm)		Description	Connection	Material	Colour
	From	To				
DD073	204x60 (to single AirBrick)	Ø100	In-line Adapter Rectangular - Round	Duct/Male	PVC	White

## RIGID DUCTING | IN-LINE ADAPTER

### In-line Adapter, Rectangular to Round (204x60 - Ø125mm)



204x60 - Ø125mm

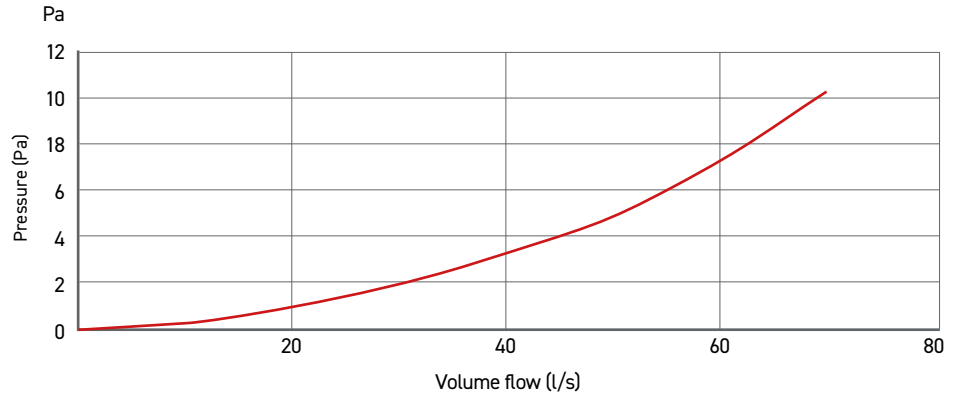

#### Resistance data in Pascals (Pa)

@10l/s	@20l/s	@30l/s	@40l/s	@50l/s	@60l/s	@70l/s
0.3	1.0	2.0	3.3	5.0	7.3	10.4

Code	Size (mm)		Description	Connection	Material	Colour
	From	To				
570	204x60	Ø125	In-line Adapter Rectangular - Round	Female/Duct	PVC	White

### In-line Adapter, Rectangular to Round (220x90 - Ø150mm)



220x90 - Ø150mm

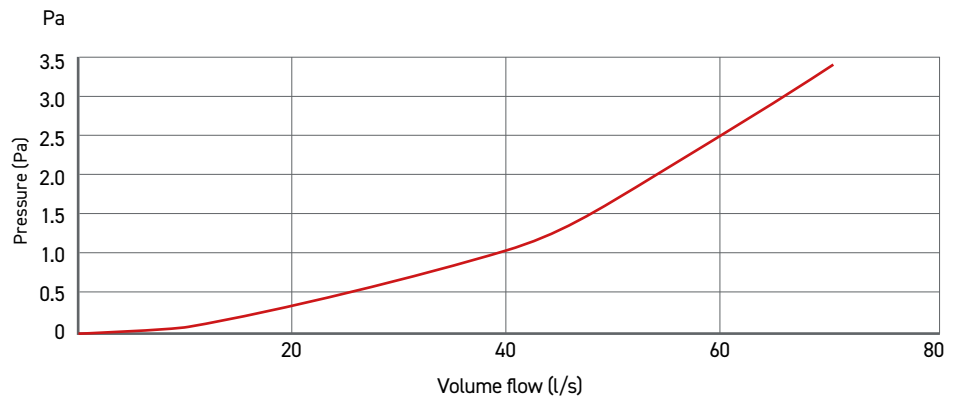

#### Resistance data in Pascals (Pa)

@10l/s	@20l/s	@30l/s	@40l/s	@50l/s	@60l/s	@70l/s
0.1	0.3	0.7	1.0	1.6	2.5	3.4

Code	Size (mm)		Description	Connection	Material	Colour
	From	To				
970	220xØ150	Ø150	In-line Adapter Rectangular - Round	Female/Female	PVC	White

## RIGID DUCTING | IN-LINE ADAPTER

In-line Adapter, Rectangular to Round (227x133 –  $\varnothing$ 100,  $\varnothing$ 125,  $\varnothing$ 150mm)



227x133mm –  
 $\varnothing$ 100,  $\varnothing$ 125,  $\varnothing$ 150mm

Performance data for double AirBrick (code 954) with adapter (954)

Resistance data in Pascals (Pa)								
Size	@10l/s	@20l/s	@30l/s	@40l/s	@50l/s	@60l/s	@70l/s	@80l/s
$\varnothing$ 125 Supply	0.8	2.9	6.6	11.5	18.0	26.1	35.9	47.2
$\varnothing$ 125 Extract	0.0	0.2	0.4	0.7	1.1	1.7	2.3	4.0
$\varnothing$ 150 Supply	0.5	1.9	4.3	7.6	11.7	17.0	23.1	29.0
$\varnothing$ 150 Extract	0.2	0.6	1.3	2.4	3.7	5.1	6.9	8.6

Performance data for Supply (air from outside)

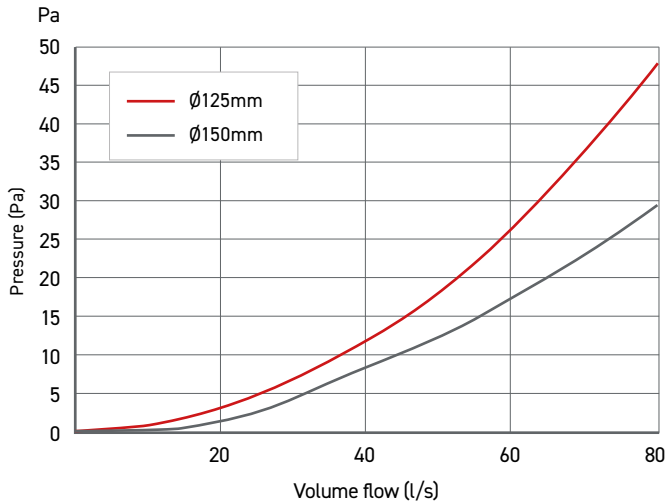

Performance data for Extract (air to outside)

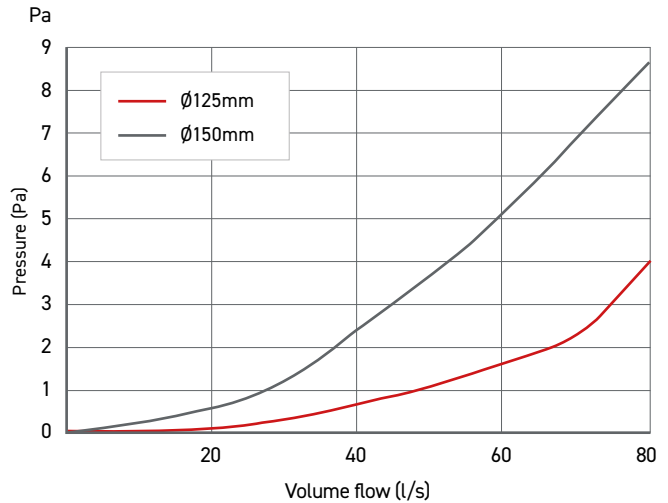

Code	Size (mm)	Description	Connection	Material	Colour	
	From	To				
954	227x133 (to double AirBrick)	$\varnothing$ 100, $\varnothing$ 125, $\varnothing$ 150	In-line Adapter Rectangular – Round	Female/Male/ Male/Male	PVC	White

## RIGID DUCTING | IN-LINE ADAPTER

### In-line Adapter, Rectangular to Rectangular (204x60 – 110x54mm)



204x60 – 110x54mm

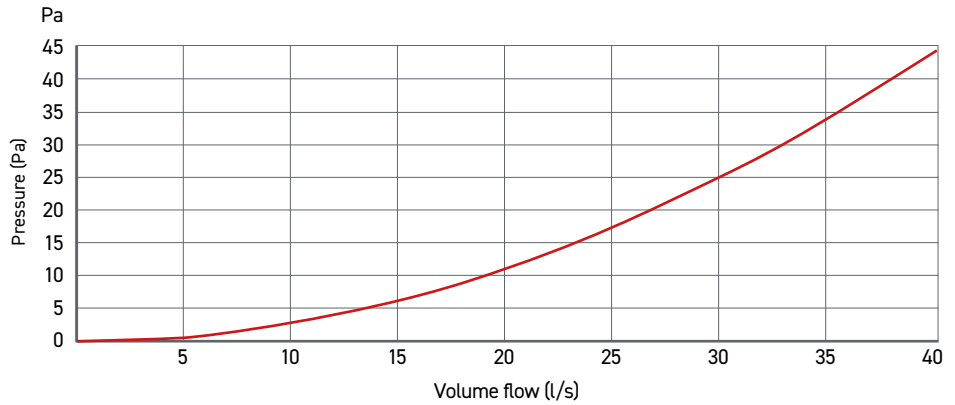

#### Resistance data in Pascals (Pa)

@5l/s	@10l/s	@15l/s	@20l/s	@25l/s	@30l/s	@35l/s	@40l/s
0.7	2.9	6.3	11.2	17.4	25.3	34.0	44.2

Code	Size (mm)		Description	Connection	Material	Colour
	From	To				
DD077	204x60	110x54	In-line Adapter Rectangular – Rectangular	Duct/Male	PVC	White

### In-line Adapter, Rectangular to Rectangular (220x90 – 204x60mm)



220x90 – 204x60mm

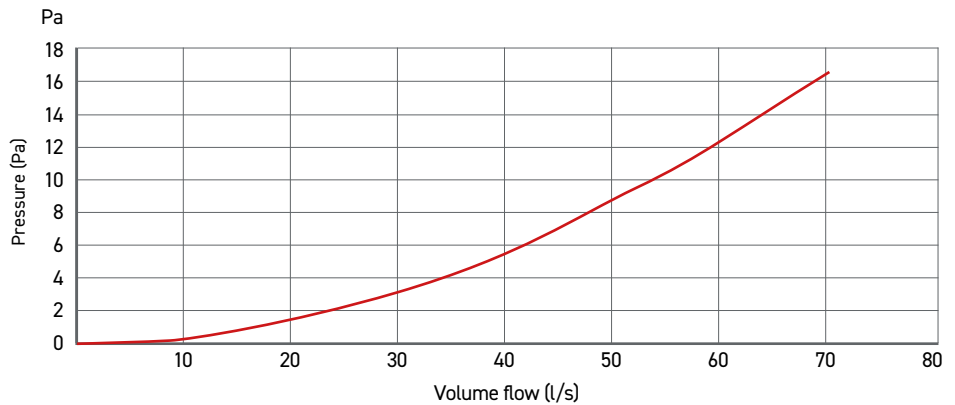

#### Resistance data in Pascals (Pa)

@10l/s	@20l/s	@30l/s	@40l/s	@50l/s	@60l/s	@70l/s
0.4	1.4	3.3	5.6	8.8	12.6	16.5

Code	Size (mm)		Description	Connection	Material	Colour
	From	To				
957	220x90	204x60	In-line Adapter Rectangular – Rectangular	Duct/Female	PVC	White



## RIGID DUCTING | IN-LINE ADAPTER

### In-line Adapter, Rectangular to Rectangular (220x90 – 204x60mm)



220x90 – 204x60mm

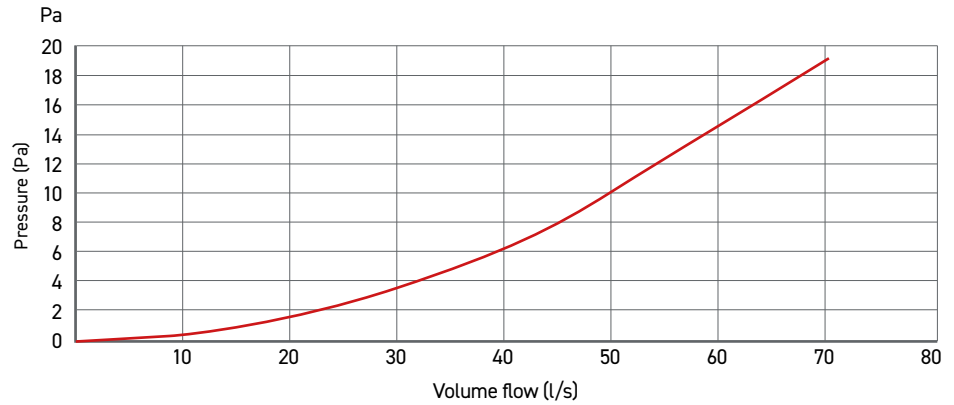

#### Resistance data in Pascals (Pa)

@10l/s	@20l/s	@30l/s	@40l/s	@50l/s	@60l/s	@70l/s
0.5	1.7	3.7	6.4	10.2	14.7	18.8

Code	Size (mm)		Description	Connection	Material	Colour
	From	To				
958	220x90	204x60	In-line Adapter Rectangular – Rectangular	Female/ Female	PVC	White

### In-line Adapter, Rectangular to Rectangular (227x133 – 220x90mm)



227x133 – 220x90mm

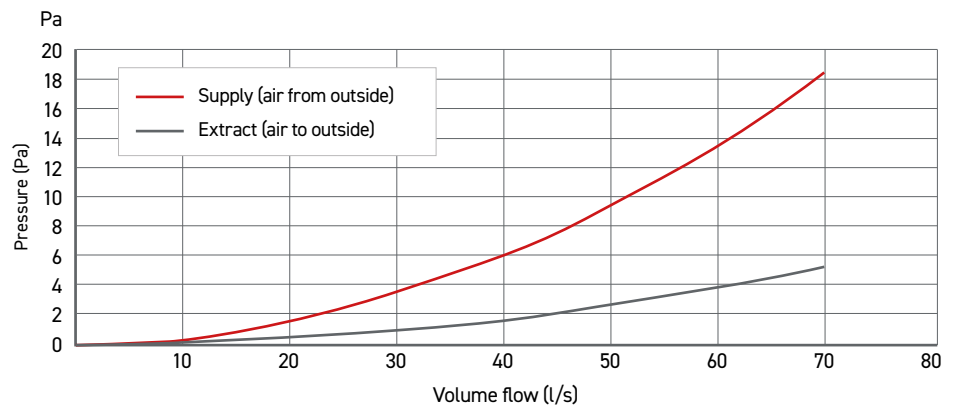

Performance data for double AirBrick (code 905) with adapter (977)

#### Resistance data in Pascals (Pa)

	@10l/s	@20l/s	@30l/s	@40l/s	@50l/s	@60l/s	@70l/s
Supply	0.4	1.5	3.5	6.0	9.3	13.3	18.2
Extract	0.1	0.5	1.0	1.7	2.7	3.9	5.2

Code	Size (mm)		Description	Connection	Material	Colour
	From	To				
977	227x133 (to double AirBrick)	220x90	In-line Adapter Rectangular – Rectangular	Male/Female	PVC	White

## RIGID DUCTING | PLENUMS

### Fixed Socket Plenum, Rectangular to Round (110x54 – Ø100mm)



110x54 – Ø100mm

#### Resistance data in Pascals (Pa)

Size	@5l/s	@10l/s	@15l/s	@20l/s	@25l/s	@30l/s	@35l/s	@40l/s
Supply – 300mm length pipe	0.4	1.2	3.0	5.2	8.0	11.6	15.6	20.5
Extract – 300mm length pipe	1.4	5.3	11.6	20.4	31.9	45.3	62.0	79.9
Supply – 2000mm length pipe	0.3	0.9	2.2	3.9	6.3	9.1	12.0	15.7
Extract – 2000mm length pipe	1.0	3.0	7.0	12.5	20.1	28.5	38.9	51.3

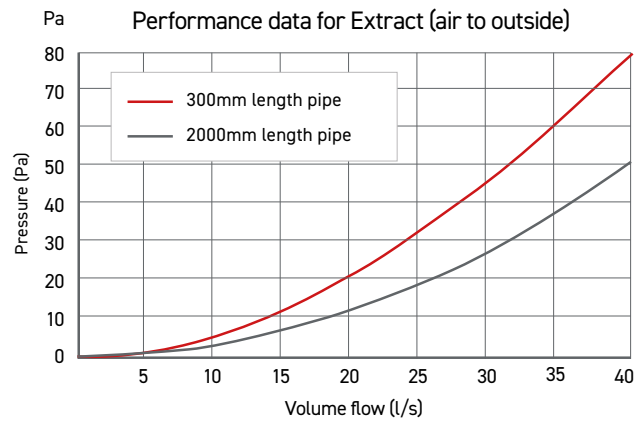
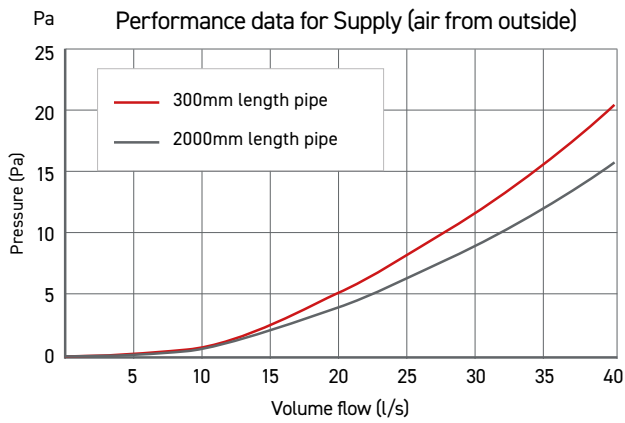

Code	Size (mm)		Description	Connection	Material	Colour
	From	To				
DD030	110x54	Ø100	Fixed Socket Plenum Rectangular – Round	Female/Duct	PVC	White

### Fixed Spigot Plenum, Rectangular to Round (110x54 – Ø100mm)



110x54 – Ø100mm

#### Resistance data in Pascals (Pa)

Size	@5l/s	@10l/s	@15l/s	@20l/s	@25l/s	@30l/s	@35l/s	@40l/s
Supply – 300mm length pipe	0.3	0.8	2.0	3.6	5.4	7.5	10.6	13.6
Extract – 300mm length pipe	1.2	4.9	10.5	18.6	28.4	41.5	56.1	73.3
Supply – 2000mm length pipe	0.3	0.6	1.5	2.8	4.2	6.2	8.4	10.6
Extract – 2000mm length pipe	0.9	2.7	5.9	10.3	16.4	23.5	31.4	41.0

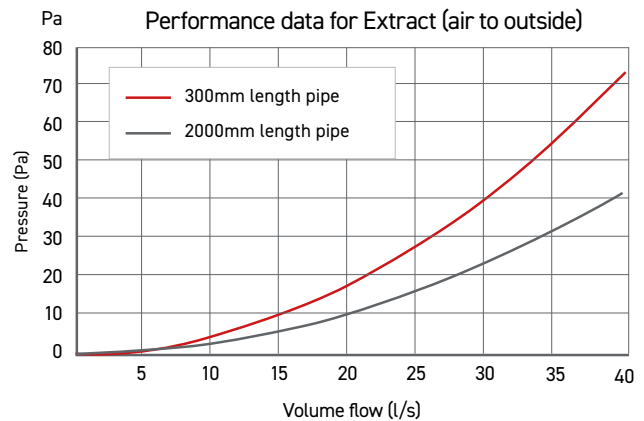
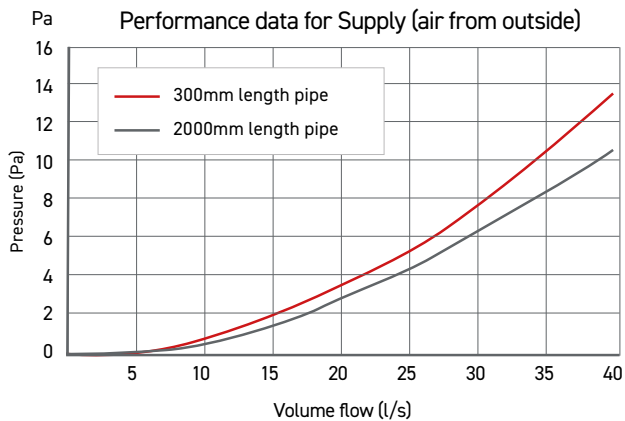

Code	Size (mm)		Description	Connection	Material	Colour
	From	To				
DD040	110x54	Ø100	Fixed Spigot Plenum Rectangular – Round	Female/Male	PVC	White

## RIGID DUCTING | PLENUMS

### Fixed Spigot Plenum, Rectangular to Round (204x60 – Ø125mm)



#### Resistance data in Pascals (Pa)

Size	@10l/s	@20l/s	@30l/s	@40l/s	@50l/s	@60l/s	@70l/s	@80l/s
Supply – 300mm length pipe	0.8	3.0	6.5	12.3	18.4	25.4	32.8	37.1
Extract – 300mm length pipe	1.7	6.5	14.1	25.0	39.3	56.7	75.7	88.7
Supply – 2500mm length pipe	0.1	3.3	7.1	12.8	18.9	25.8	33.5	37.2
Extract – 2500mm length pipe	1.3	4.1	8.6	15.1	22.9	32.7	44.9	53.1

204x60 – Ø125mm

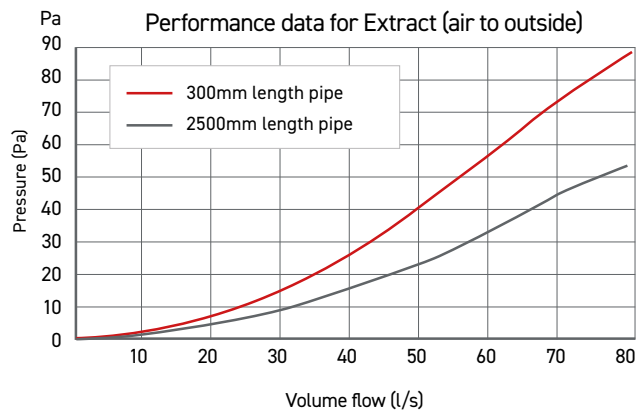
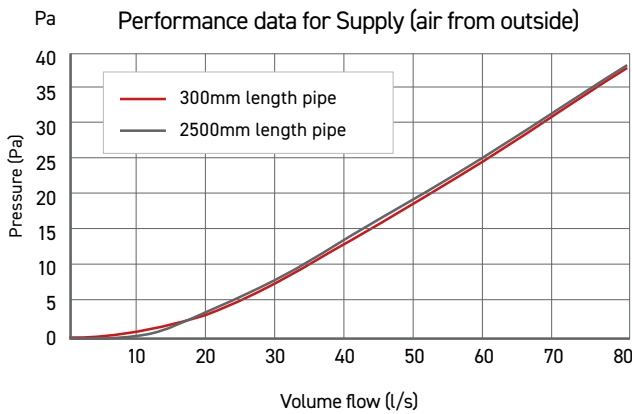

Code	Size (mm)		Description	Connection	Material	Colour
	From	To				
540	204x60	Ø125	Fixed Spigot Plenum Rectangular – Round	Female/Male	PVC	White

### Fixed Spigot Plenum, Rectangular to Round (204x60 – Ø150mm)



#### Resistance data in Pascals (Pa)

Size	@10l/s	@20l/s	@30l/s	@40l/s	@50l/s	@60l/s	@70l/s	@80l/s
Supply – 300mm length pipe	0.4	1.6	3.2	6.1	8.8	13.1	16.6	18.9
Extract – 300mm length pipe	1.2	4.7	10.4	18.5	28.6	40.7	54.5	68.7
Supply – 3000mm length pipe	0.4	1.1	2.0	3.0	5.0	6.8	8.5	9.7
Extract – 3000mm length pipe	0.9	3.4	7.3	12.3	19.3	28.4	38.3	47.6

204x60 – Ø150mm

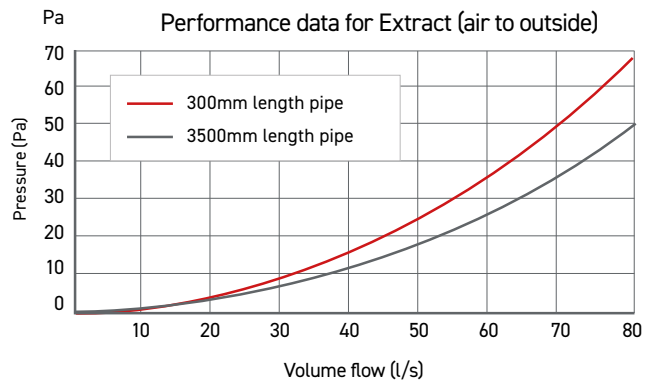
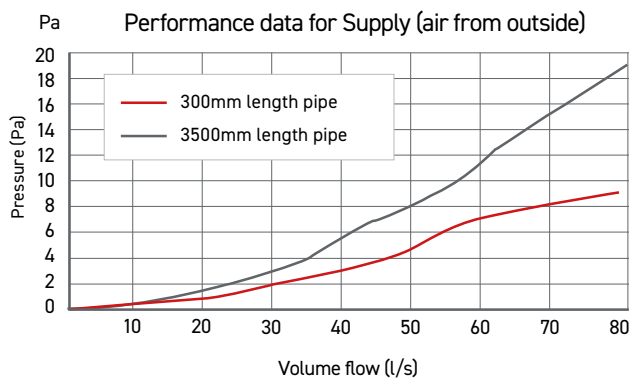

Code	Size (mm)		Description	Connection	Material	Colour
	From	To				
640	204x60	Ø150	Fixed Spigot Plenum Rectangular – Round	Female/Male	PVC	White

## RIGID DUCTING | PLENUMS

### Offset Rotating Spigot, Rectangular to Round (204x60 – Ø100mm)



#### Resistance data in Pascals (Pa)

Size	@10l/s	@20l/s	@30l/s	@40l/s	@50l/s	@60l/s
Supply (A) – 300mm length pipe	1.9	7.8	16.4	29	45.7	64.2
Extract (A) – 300mm length pipe	2.8	10.4	22.6	39.5	61.1	91.9
Supply (B) – 2000mm length pipe	2.9	12.1	28.9	56.9	89.1	113.8
Extract (B) – 2000mm length pipe	1.2	4.4	9.4	17.8	27.4	42.4

204x60 – Ø100mm

**A** = spigot furthest from socket, **B** = spigot nearest to socket

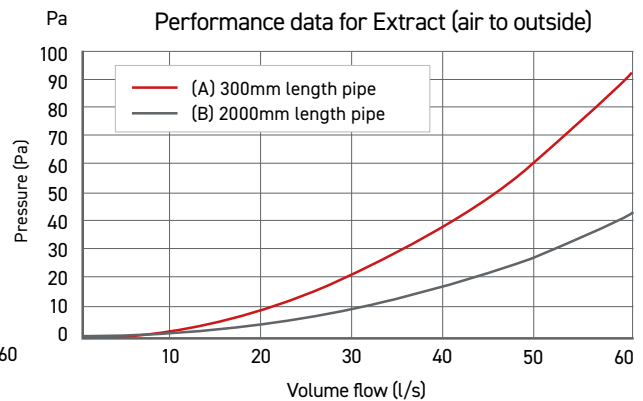
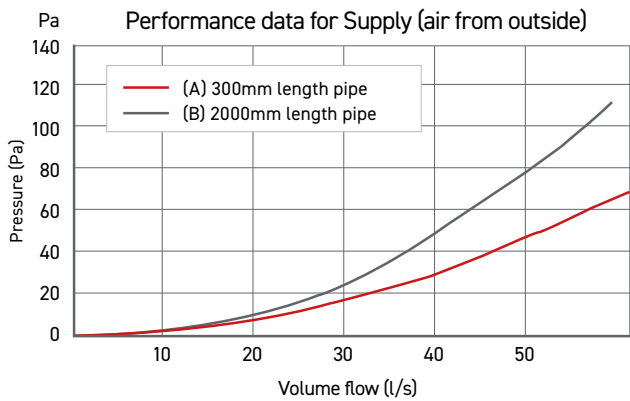

Code	Size (mm)		Description	Connection	Material	Colour
	From	To				
441	204x60	Ø100	Offset Rotating Spigot	Female/Male	PVC	White

### Offset Rotating Spigot, Rectangular to Round (204x60 – Ø125mm)



#### Resistance data in Pascals (Pa)

Size	@10l/s	@20l/s	@30l/s	@40l/s	@50l/s	@60l/s	@70l/s	@80l/s
Supply (A) – 300mm length pipe	0.8	2.8	6.1	11.2	16.5	23.2	30.6	36.6
Extract (A) – 300mm length pipe	1.6	6.2	13.6	24	37.2	54.7	73.1	88.7
Supply (B) – 2500mm length pipe	1.3	5.1	12.7	25.3	39.2	55.6	75.4	85.2
Extract (B) – 2500mm length pipe	1.2	4.4	9.7	17.2	26.2	38.1	51.7	62.1

204x60 – Ø125mm

**A** = spigot furthest from socket, **B** = spigot nearest to socket

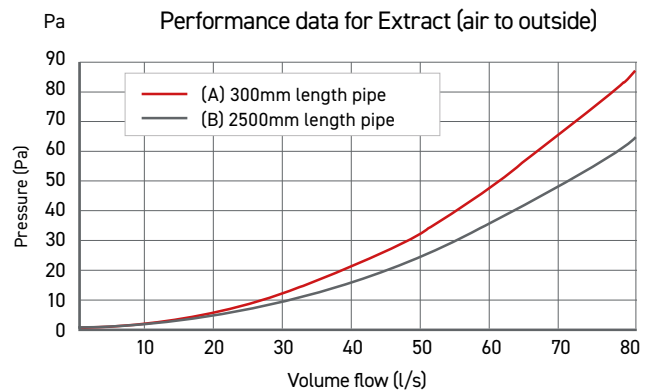
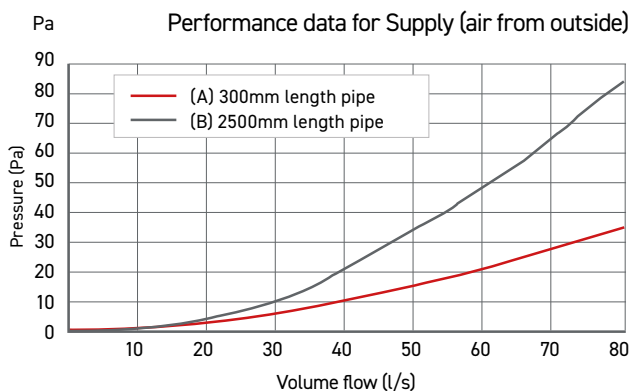

Code	Size (mm)		Description	Connection	Material	Colour
	From	To				
541	204x60	Ø125	Offset Rotating Spigot	Female/Male	PVC	White

## RIGID DUCTING | PLENUMS

### Offset Rotating Spigot, Rectangular to Round (204x60 – Ø150mm)



#### Resistance data in Pascals (Pa)

Size	@10l/s	@20l/s	@30l/s	@40l/s	@50l/s	@60l/s	@70l/s	@80l/s
Supply (A) – 300mm length pipe	0.3	0.8	1.4	2.6	3.6	4.6	5.6	6.1
Extract (A) – 300mm length pipe	0.8	3.0	6.3	11.0	16.9	24.5	33.7	41.2
Supply (B) – 3000mm length pipe	0.5	1.9	4.5	9.1	14.2	20.3	27.5	28.5
Extract (B) – 3000mm length pipe	0.9	3.0	6.7	11.2	17.2	25.5	34.2	42.3

204x60 – Ø150mm

**A** = spigot furthest from socket, **B** = spigot nearest to socket

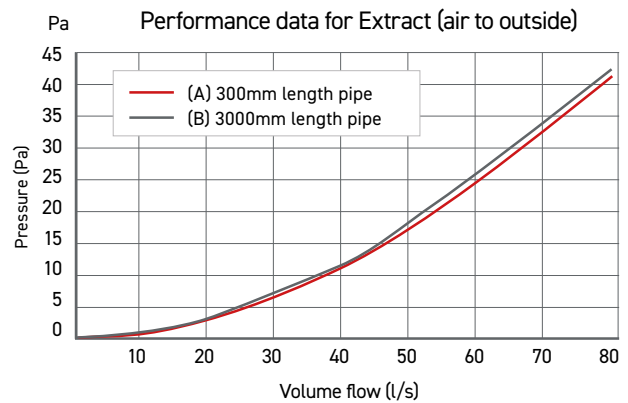
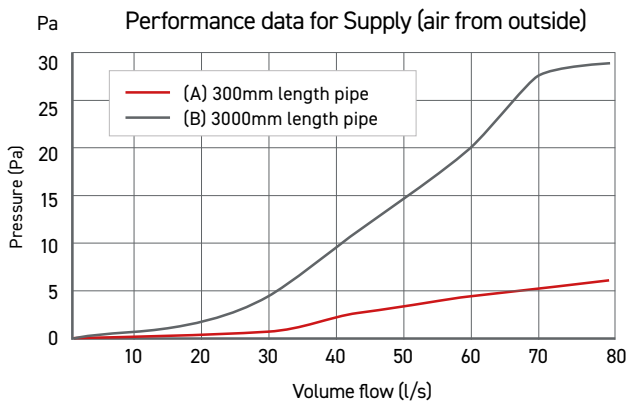

Code	Size (mm)		Description	Connection	Material	Colour
	From	To				
641	204x60	Ø150	Offset Rotating Spigot	Female/Male	PVC	White

### Offset Rotating Spigot, Rectangular to Round (220x90 – Ø100mm)



#### Resistance data in Pascals (Pa)

Size	@5l/s	@10l/s	@15l/s	@20l/s	@25l/s	@30l/s	@35l/s
Supply (A) – 300mm length pipe	0.6	1.9	4.3	7.9	11.8	16.9	22.8
Extract (A) – 300mm length pipe	0.1	0.2	0.4	0.8	1.1	1.7	2.0
Supply (B) – 300mm length pipe	0.5	2.9	6.4	12.2	19.3	29.6	40.0
Extract (B) – 300mm length pipe	0.2	0.8	1.6	2.9	4.6	6.7	9.2

220x90 – Ø100mm

**A** = spigot furthest from socket, **B** = spigot nearest to socket

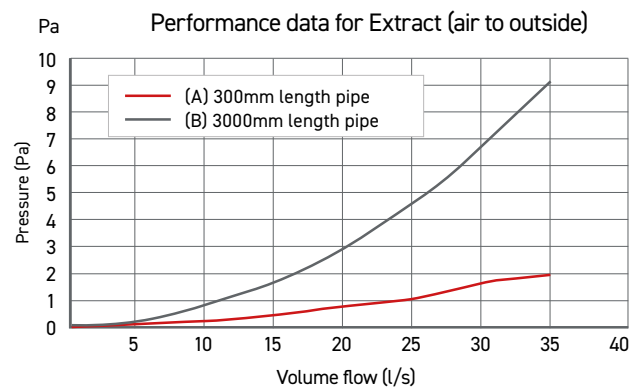
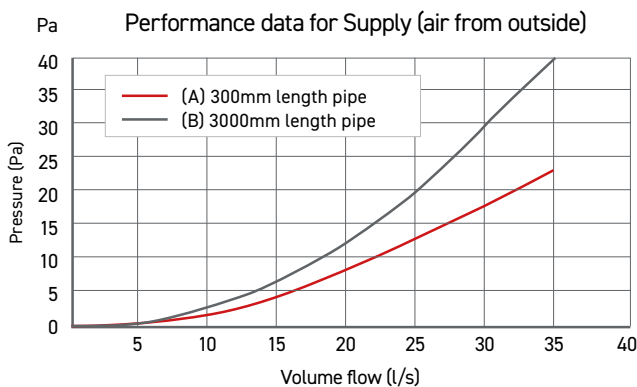

Code	Size (mm)		Description	Connection	Material	Colour
	From	To				
941	220x90	Ø100	Offset Rotating Spigot	Female/Male	PVC	White

## RIGID DUCTING | PLENUMS

### Offset Rotating Spigot, Rectangular to Round (220x90 – Ø125mm)



220x90 – Ø125mm

Resistance data in Pascals (Pa)							
Size	@10l/s	@20l/s	@30l/s	@40l/s	@50l/s	@60l/s	@70l/s
Supply (A) – 300mm length pipe	0.9	2.8	6.4	11.0	16.7	24.5	33.2
Extract (A) – 300mm length pipe	0.3	0.9	2.1	3.4	5.2	7.5	10.2
Supply (B) – 2500mm length pipe	1.0	4.7	10.9	20.3	33.1	49.5	66.9
Extract (B) – 2500mm length pipe	0.6	2.0	4.5	7.9	12.1	18.1	24.8

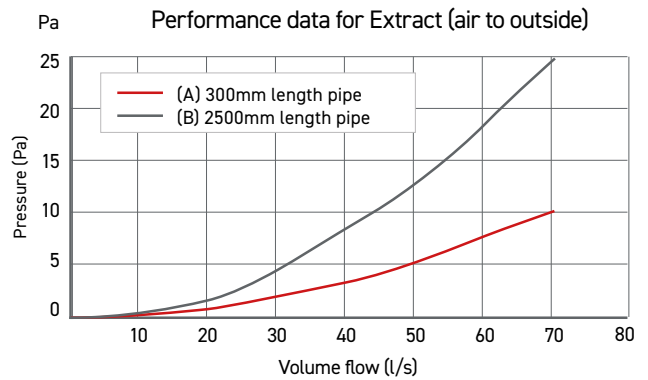
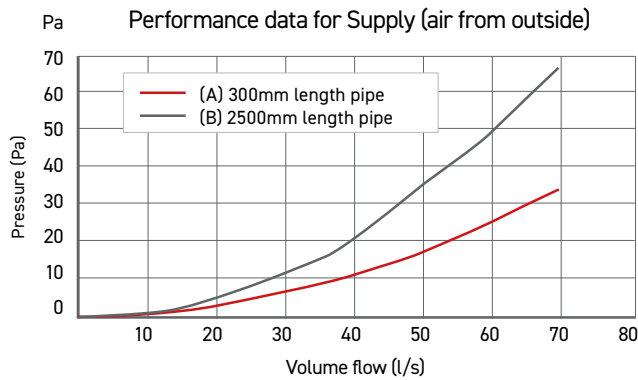

Code	Size (mm)		Description	Connection	Material	Colour
	From	To				
951	220x90	Ø125	Offset Rotating Spigot	Female/Male	PVC	White

### Offset Rotating Spigot, Rectangular to Round (220x90 – Ø150mm)



220x90 – Ø150mm

Resistance data in Pascals (Pa)							
Size	@10l/s	@20l/s	@30l/s	@40l/s	@50l/s	@60l/s	@70l/s
Supply (A) – 300mm length pipe	0.3	1.2	2.8	5.0	7.7	11.2	15.4
Extract (A) – 300mm length pipe	0.7	2.6	5.7	10.3	15.6	22.5	31.0
Supply (B) – 3000mm length pipe	0.5	1.9	4.7	8.4	13.7	20.6	27.5
Extract (B) – 3000mm length pipe	0.6	1.8	4.0	6.5	10.2	14.6	19.9

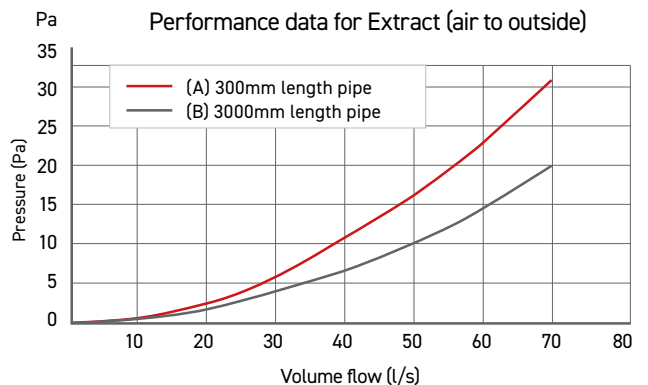
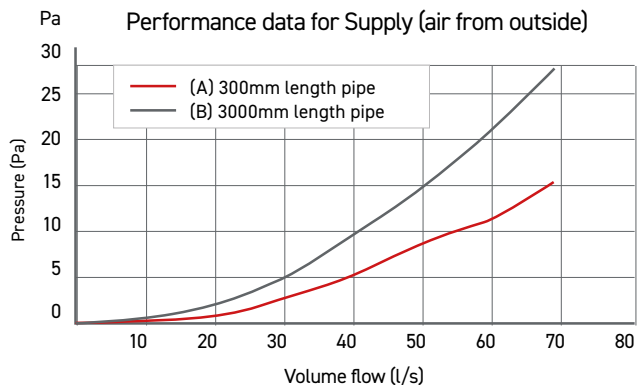

Size (mm)	Description		Connection	Material	Colour	Code
	From	To				
220x90	Ø150	Offset Rotating Spigot	Female/Male	PVC	White	961

# ▶ DOMUS RADIAL

Whole house air distribution systems, which provide simple, quick and hassle free installation, to save time and money.

Domus Radial systems are a clever plug and play whole house ventilation solution, which use manifold distribution to evenly service each room through semi-rigid duct. These systems incorporate a centralised mechanical unit; either a Mechanical Ventilation with Heat Recovery (MVHR) or Mechanical Extract Ventilation (MEV).

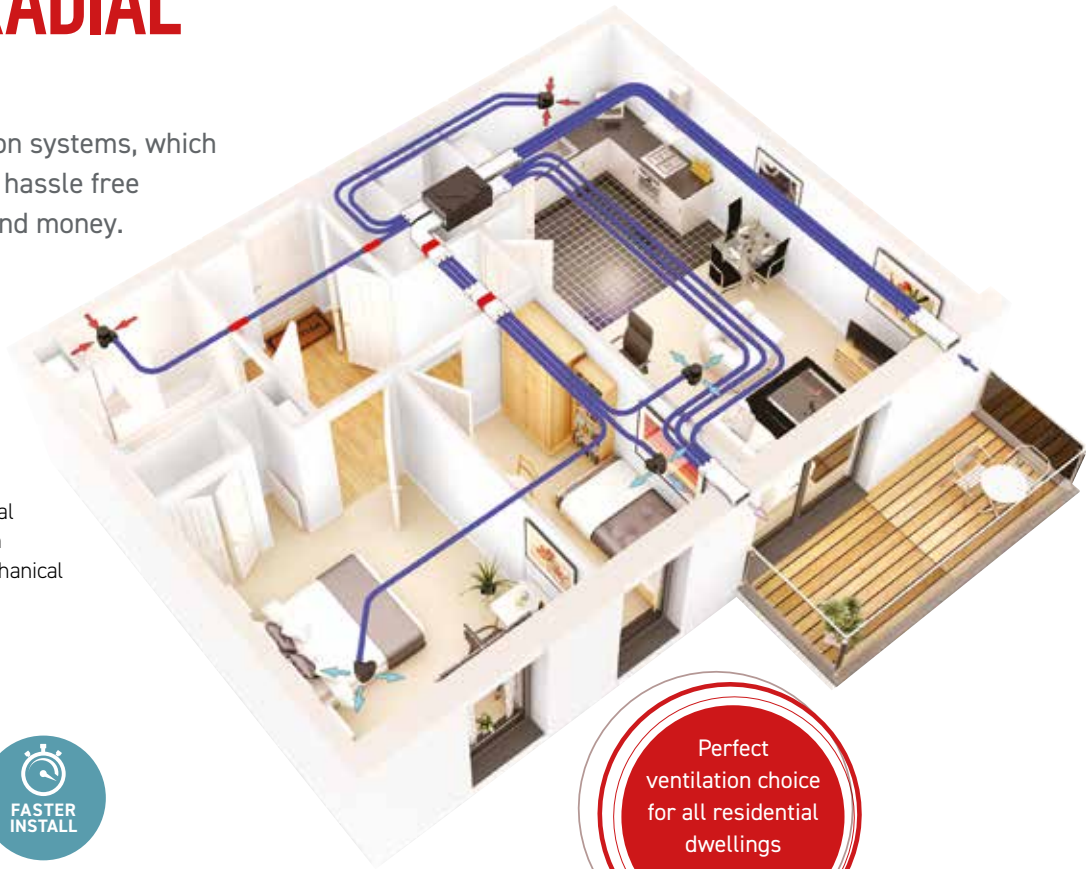

## What is different about Domus Radial?

- ▶ Slimline manifold (125mm deep) enables easy installation between joists or in tight spaces, where required for larger developments.
- ▶ Optional integral flow control device allows the outlet plenum to be connected directly to a stylish architectural grille – no air valve necessary.
- ▶ Rapid fixing mechanism enables secure and air-tight connection with no leakages.

- ▶ Corrugated construction and the unique formulation of semi-rigid duct resists stress cracking and on-site damage.



- ▶ Can integrate with Domus rigid duct systems to create versatile hybrid solutions.
- ▶ Fire-stopping and insulation components also available.

**i** Tested by the **Building Research Establishment (BRE)** for inclusion within the Product Characteristics Database, Domus Radial offers performance levels that not only are the equivalent to traditional rigid ducting in smaller builds, but also exceed these levels in properties with four or more wet rooms.

Our award winning Domus Radial semi-rigid duct systems provide simple, quick and hassle free design and installation which saves time and money, whilst maximising in-situ performance.



Domus Radial duct with a Flow Control Plenum, connecting to a stylish grille



Domus Radial duct with Fire Protection Sleeve



Domus Radial duct with Insulation



Easy Adjustment of Domus Flow Control Plenum



A Domus Radial Flow Control Plenum will allow the integration of stylish Domus grilles

## Installation

The simple plug and play mechanism between the semi-rigid duct and manifold, as well as the plenum's clip-on fixing system, make Domus Radial ultra-quick to install. As directed in our simple online step-by-step installation guide, the only tools you will require are:

- ▶ Pozidrive screwdriver
- ▶ Long reach spanner
- ▶ Cutting tool
- ▶ Allen key

**Domus Radial is available as pre-selected house packs, as well as individual parts.**



























# RADIAL PARTS

Parts that may be needed to make up a Domus Radial system.

Property configurations vary, which is why the flexibility of our Radial system is so useful. A 50m coil that negates the need for multiple bends resulting in reduced system resistance, and can be cut to length at your convenience. For FREE layout and technical advice email: [vent.projects@domusventilation.co.uk](mailto:vent.projects@domusventilation.co.uk)



Type	Code	Description
<b>Radial Semi-Rigid Duct and Clips</b>		
	RDD75	Semi-Rigid Duct, Ø75mm - 50m Coil
	RDD7590	Semi-Rigid 90 degree duct connector 75mm
	RDC75	Semi-Rigid duct connector 75mm
	RDCLIP75	Duct Clips, Ø75mm - Pack of 10
	RDPC75	Manifold Protective Caps
<b>Radial Manifolds and Domus Adapts</b>		
	RDM-EP150	Manifold (Round)
	RDM-MD220	Manifold (Rectangular)
	RDLAB	Manifold Extract and Supply Label Kits
	RDA-3FA	Adapt 204x60mm In-Line Adapter 3xØ75mm Radial Sockets, Female adapter
	RDA-3FC	Adapt 220x90mm In-Line Adapter 3xØ75mm Radial Sockets, Duct only

Type	Code	Description
<b>Radial Manifolds and Domus Adapts</b>		
	RDA-3FV90	Adapt 220x90mm Vertical 90° Bend 3xØ75mm Radial Sockets
	RDA-3FH90	Adapt 220x90mm Horizontal 90° Bend 3xØ75mm Radial Sockets
<b>Radial Semi-Rigid Duct Components</b>		
	RDA-3R90-125	Adapt Ø125mm Plenum 3xØ75mm Radial Sockets
	RDA-3R90-150	Adapt Ø150mm Plenum 3xØ75mm Radial Sockets
	RDA-3T	Adapt 220x90mm T Piece 3xØ75mm Radial Sockets
	RDA-6T	Adapt 220x90mm T Piece 6xØ75mm Radial Sockets
	RDA-6TB	Adapt 220x90mm T Piece 3xØ75mm Radial Sockets 3 from Branch
	RDA-CSK3	Adapt Spares 2 Blanking Caps, 3 Clips and 3 Seals
	RDA-CSK6	Adapt Spares 4 Blanking Caps, 6 Clips and 6 Seals
	RDS75	Rubber seals x10
<b>Radial Semi-Rigid Duct Fire Solutions</b>		
	RDA-FSK	Adapt Fire Sleeve
	RDFS75	Semi-Rigid Duct Fire-Stopping Sleeve
<b>Plenums and Internal Terminals</b>		
	RDOP-125	Plenum, Ø125mm for Air Valve or RDOP-125FC OR Flow Control Plenum, Ø125mm For Architectural Grilles
	RDI-25X5M	Insulation for Ø75mm Semi-Rigid Duct

# ▶ **FLOW CONTROL PLENUM™** FOR ARCHITECTURAL GRILLES

Engineered to include an integral flow control device, enabling connection to a range of stylish architectural grilles – no air valves necessary.



## Key features & benefits

- ▶ Enables commissioning to be carried out prior to fixing ceiling boards.
- ▶ Adjusting the air terminal for commissioning is quick and easy.
- ▶ Allows simple connection to architectural grilles – no air valves necessary.
- ▶ Integral flow control device cannot be easily tampered with – reducing the risk of impacting system performance and indoor air quality.
- ▶ Commissioning rates can be agreed prior to ceilings being fixed; enabling that air flow rates will be achieved (if fitted correctly) and less risk of costly remedial work.
- ▶ Ability to integrate stylish grilles to fit interior design scheme.

Code	Description
540-FC	Domus Supertube Rigid Duct 204x60mm Flow Control Plenum for Architectural Grilles White

## Performance Data

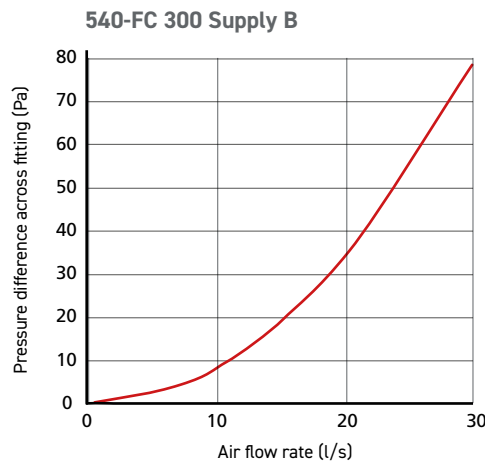
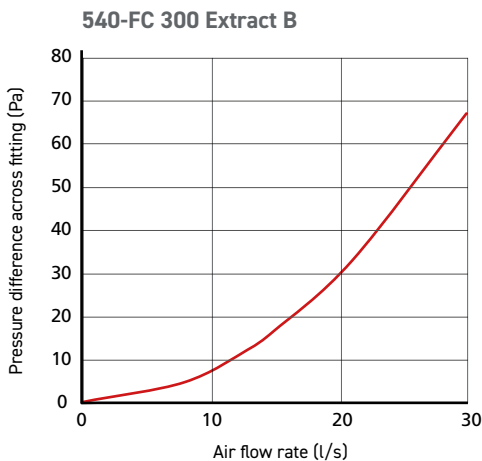
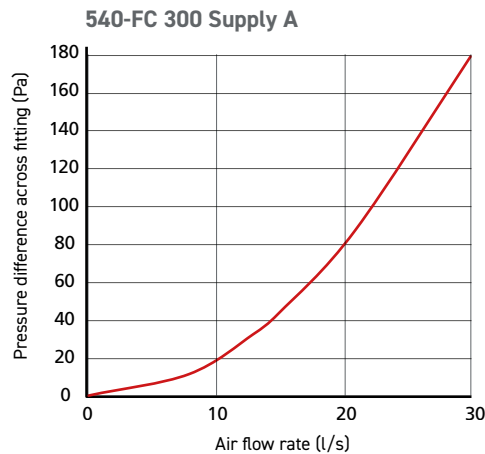
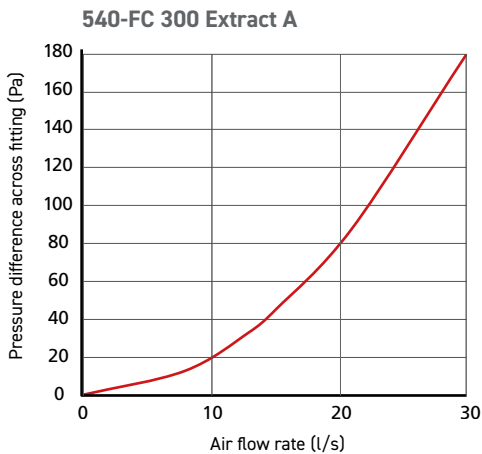

## ARCHITECTURAL GRILLES

Stylish bathroom and kitchen fan fascias,  
designed to complement modern interior design schemes.

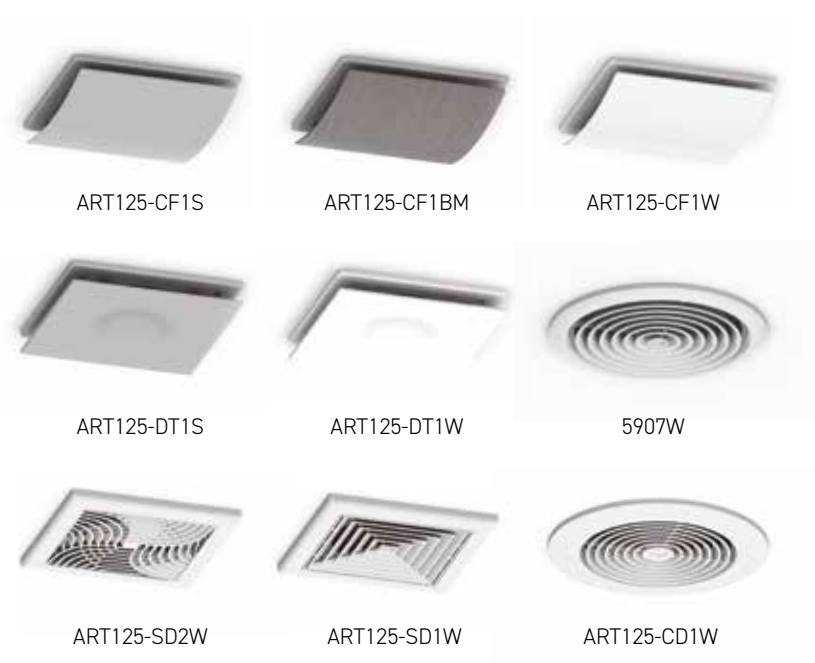

Suitable for 125mm connection.

# ▶ ATTENUATION



Our Rigid Duct Attenuators offer excellent sound absorption over a range of audible frequencies.

Our rigid duct sound attenuator range now includes variants with even better sound attenuation performance, at the levels which count – the frequency in which room-to-room cross talk and appliance noise are more prominent to our hearing.

Code	Size
5SL-500	204x60mm
9SL-500	220x90mm

## Key features & benefits

- ▶ Best performing plastic attenuation on the market.
- ▶ Excellent sound attenuation properties as verified by the Sound Research Laboratories (SRL).
- ▶ Tamper proof.
- ▶ Significantly reduces transmitted appliance noise and room-to-room cross talk.
- ▶ Protected foam helps enable a long life, clean and fresh ventilation system.
- ▶ Low profile increases installation options and offers greater flexibility.
- ▶ Lightweight and easy to fit for quicker installation time.
- ▶ Can also be used with Domus Thermal duct insulation.
- ▶ Helps facilitate occupant acceptance of a continuously running centralised ventilation system.
- ▶ Helps achieve Building Regulation recommendations.
- ▶ The installation of Domus Ventilation rigid duct attenuators over metal alternatives, provides peace of mind that future replacement owing to corrosion won't occur.

## Why use sound attenuators?

- ▶ Noise generated by a mechanical extract appliance could result in occupants incorrectly altering the performance of their system and, as a consequence, detrimentally impacting indoor air quality.
- ▶ To avoid this, Building Regulations stipulate that the system should not produce excessive noise that could discourage occupants from using it correctly.
- ▶ In addition to this, resident cross talk carried through connecting room-to-room ducting can also impair homeowner comfort.

## Installation

Rigid duct attenuators can be installed in roof and ceiling voids and are recommended to be fitted on the room-side of the ventilation appliance, to limit cross talk and to be near each inlet and outlet.

## Range

To support the most popular rectangular rigid duct profiles our attenuators are available to install with 204x60mm and 220x90mm duct systems.

The attenuator can bolt together with connector **520** or **920** to increase length.



## Materials

Duct attenuator: PVC plastic ducting

Acoustic Foam Material: High Density Reconstituted PVC/Nitrile Foam with a density of 240kg/m<sup>3</sup>. Foam contains a unique uniform cell structure, offering excellent sound absorption properties, particularly at low frequency.

Flame Retardant, compliant to BS476 Part 7 Class 1, UL94-HF1, UL94-V0 (tested by Warrington Fire) and FMVSS 302.

## Regulations

Approved Document F of the Building Regulations F1 Means of Ventilation recommends that the system should not produce excessive noise that could discourage occupants from using it correctly.

A rigid duct attenuator should, therefore, form part of the duct system, to ensure occupants do not incorrectly alter the performance of the system and as a consequence, detrimentally impact indoor air quality.



Sound Absorption Characteristics								
Code	Size (mm)	125Hz	250Hz	500Hz	1000Hz	2000Hz	4000Hz	8000Hz
5SL-500	204x60	0.2	4.2	7.4	19	19.3	21.6	22.2
9SL-500	220x90	2.9	3.5	12.3	15.5	17	18.1	18.8

Code	Size	Description	Material	Colour
5SL-500	204x60mm	204mm x 60mm x 0.5m Attenuator (male/male)	uPVC casing	White

Performance data											
Airflow rate V (l/s)	0	10	20	30	40	50	60	70	80	90	
Pressure drop (Pa)	0.0	1.8	5.8	12.1	20.6	32.0	46.0	62.8	82.9	106.0	

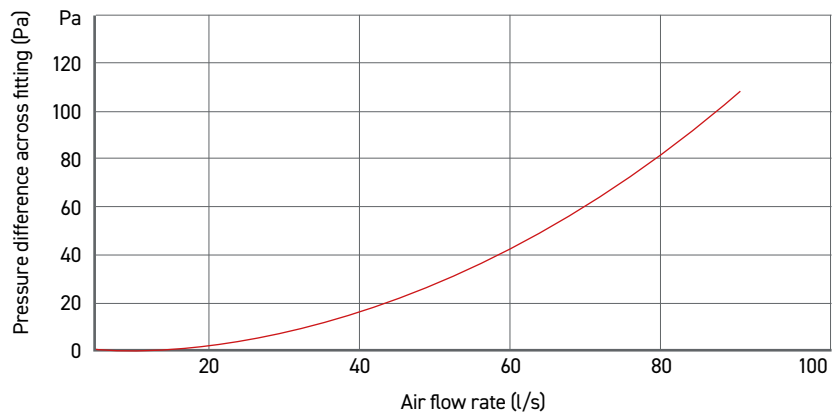
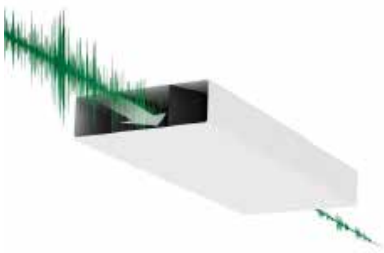

Code	Size	Description	Material	Colour
9SL-500	220x90mm	220mm x 90mm x 0.5m Attenuator (male/male)	uPVC casing	White

Performance data											
Airflow rate V (l/s)	0	5	10	15	20	25	30	35	40	50	60
Pressure drop (Pa)	0	0.1	0.4	1.0	1.6	2.5	3.4	4.5	5.8	8.8	12.4

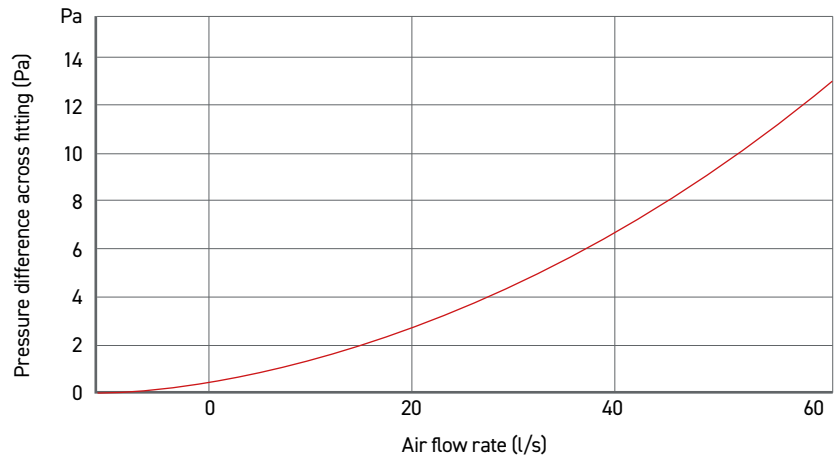
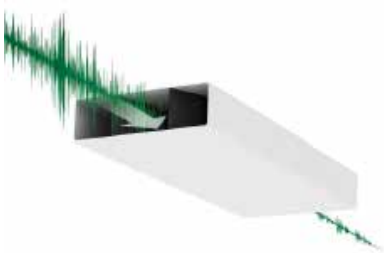

## Acoustic sound results

### 5SL-500

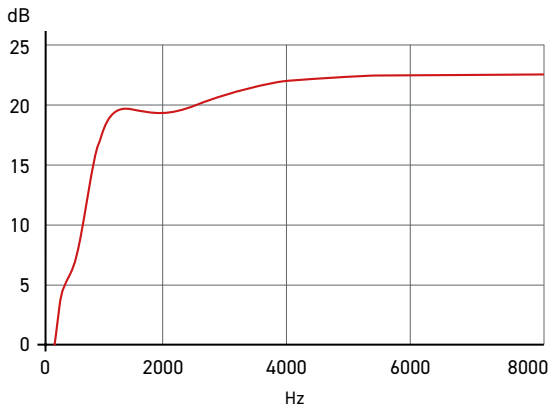

### 9SL-500

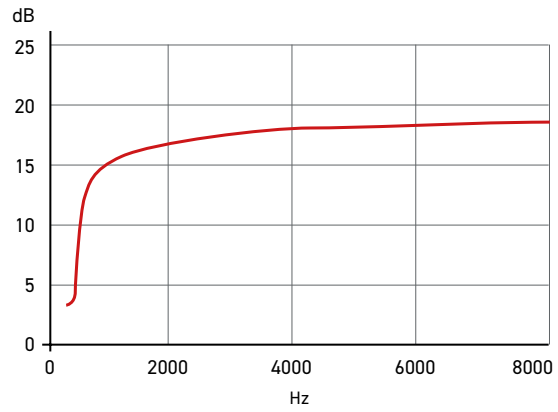

## Cumulative length acoustic sound results

### Octave Band Insertion Loss - 5SL-500

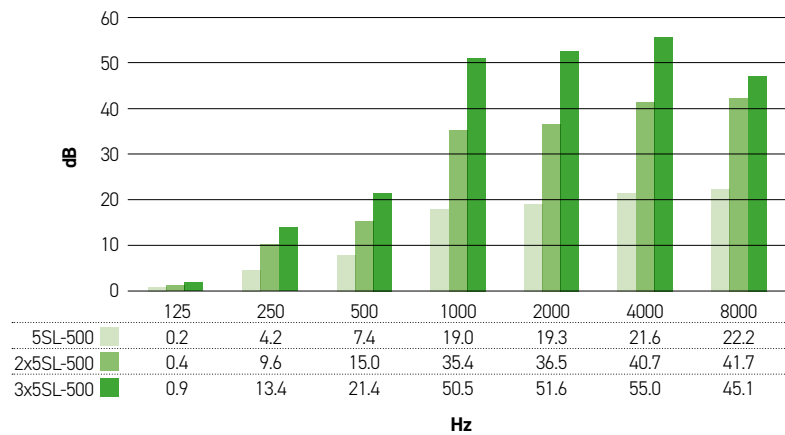

The diagrams illustrate the increased sound absorption levels when close-coupling up to three individual 0.5m lengths of rigid duct attenuators, thus reducing noise levels by up to 55dB.

### Octave Band Insertion Loss - 9SL-500

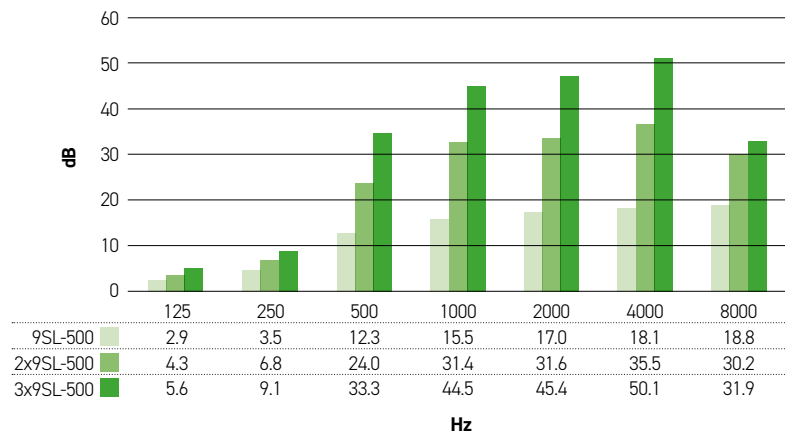



# ▶ THERMAL DUCT INSULATION

As an integral part of Domus rigid duct systems, Domus Thermal™ is a unique and patented duct insulation solution. Designed specifically to radically improve the thermal insulation of rigid duct passing through unheated spaces in domestic properties.



## What is Domus Thermal?

- ▶ A range of EPS insulation components specifically designed to insulate round or rectangular domestic ventilation ducting passing through cold areas.
- ▶ A method of significantly reducing heat loss and virtually eliminating the formation of condensation.
- ▶ The first engineered duct insulation system available to comply with recent improvements to Building Regulations.



- ▶ An installer-friendly solution which can be fitted quickly and reliably without the need for gluing or taping.

## Why use Domus Thermal?

- ▶ Approved Document F of Building Regulations 2021 states that all ducting installed in domestic properties, which passes through unheated areas or loft spaces, should be insulated with the equivalent of at least 25mm of a material having a thermal conductivity of  $\leq 0.04$  W/(m.K) to reduce the possibility of condensation forming.
- ▶ The loss of heat through poorly insulated duct systems means that modern homes are at risk of losing a valuable source of energy; for example, when using warm exhaust air to heat fresh incoming air through an MVHR system or exhaust air heat pump.
- ▶ Domus Thermal exceeds these regulations, having a thermal conductivity of  $0.03$  W/(m.K), thus providing better insulation and peace of mind that the system will be compliant and save energy. This greatly improved thermal conductivity allows the wall thickness to be reduced to just 20mm in most profiles.

## What is different about Domus Thermal?

### Complies with Building Regulations

The only engineered duct insulation solution which complies with 2021 Building Regulations. The thermal performance of the range, in relation to 2021 Building Regulations, has been independently ratified by one of the UK's leading thermodynamics experts.

#### Building Regulations demand:

$\leq 0.04$  W/(m.K) thermal conductivity at 25mm insulation thickness.

Minimum thermal resistance or R-value =  $0.025/0.04 = 0.625$  K/W.

#### Domus Thermal provides:

$\leq 0.03$  W/(m.K) thermal conductivity at 20mm insulation thickness.

Minimum thermal resistance or R-value =  $0.020/0.03 = 0.666$  K/W.

The increased thermal resistance of Domus Thermal, therefore, exceeds current Building Regulations.

### Installation

Currently, compliant solutions are more labour intensive and require higher skill levels to install. Domus Thermal's simple interlocking feature means that the system is quicker and easier to install. This revolutionary method can, therefore, significantly reduce installation costs.

### Breadth of range

Domus Thermal is available in a range of profiles and fittings to insulate the Domus EasiPipe (round) and Supertube (rectangular) duct systems.

To support the system, PVC coated, perforated steel banding is also available for surface mounting or suspending the insulated system. The use of this soft-edged fixing system is strongly recommended to ensure that the insulated duct is held securely without damage.

### Unique aesthetic design

The interlocking feature and regular external profile provides homeowners with a neat, professional and continuous appearance.



## Improved insulation properties

Domus Thermal is manufactured from flame retardant (EN 13163 class E) Silver EPS (expanded polystyrene), which provides its enhanced thermal insulation properties and enables the system to exceed the requirements of the current Building Regulations.

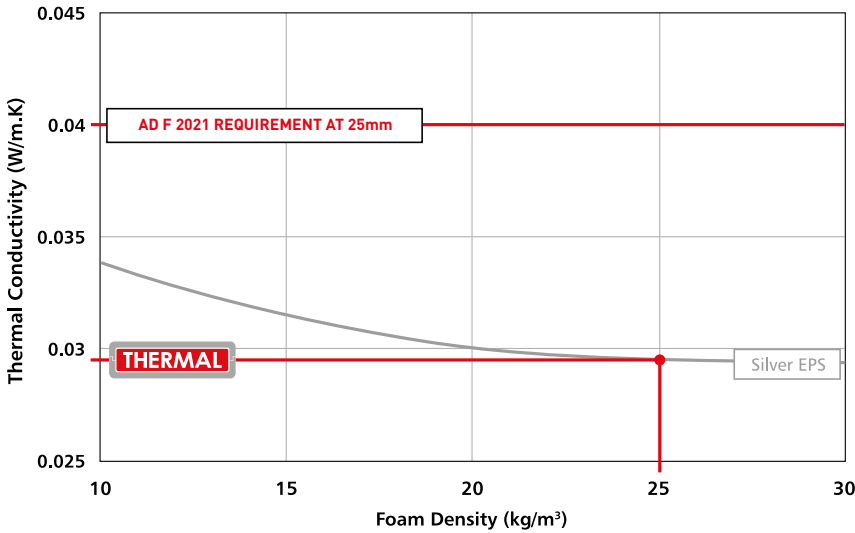

## Material

- ▶ Injection moulded, carbon impregnated Expanded Polystyrene (EPS)
- ▶ Density = 25kg/m<sup>3</sup>
- ▶ Colour: Silver/Grey

## Size

- ▶ Wall thickness 20mm and 22.25mm\*
- ▶ Components to suit 100mm internal diameter Domus EasiPipe system
- ▶ Components to suit 125mm internal diameter Domus EasiPipe system
- ▶ Components to suit 150mm internal diameter Domus EasiPipe system
- ▶ Components to suit 204mm x 60mm Domus Supertube system

\*22.25mm wall thickness only applies to 1m lengths of 204mm x 60mm

The Silver EPS used to manufacture Domus Thermal provides a significantly improved thermal conductivity value owing to the inclusion of carbon particles, which gives Domus Thermal its distinctive silver colour.

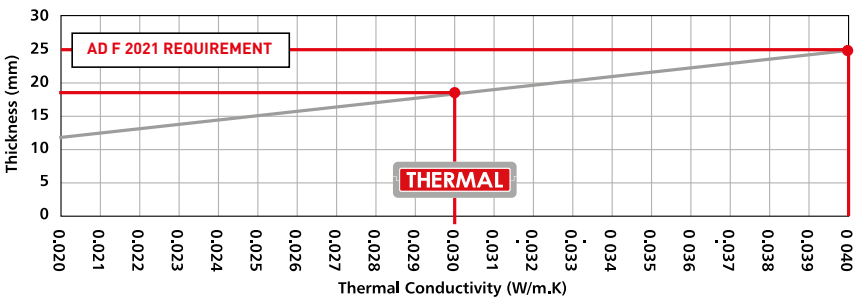

The thermal duct itself conforms to BS EN 13163. Which under section 4.2.8 references the EN 13501-1 for the reaction to fire test standard.

## Sustainability

Domus Thermal products are recyclable and when installed in accordance with Domus Ventilation's installation guidelines, Domus Thermal offers a life expectancy greater than or equal to that of the Domus duct system.

## Fire resistance

Reaction to Fire Class E to BS EN 13501-1, Fire classification of construction products and building elements.

**NOTE.** The thermal duct itself conforms to BS EN 13163. Which under section 4.2.8 references the EN 13501-1 for the reaction to fire test standard. Flame retardant to Class E of EN13163.

## Accessories

### TS22 (coated) and TS22G (not coated)

We offer a choice of coated or uncoated steel banding to support Domus Thermal. Suitable for surface mounting or suspending the insulated system.

## THE DOMUS THERMAL RANGE



Domus Thermal is available in a range of profiles and fittings to insulate the Domus EasiPipe (round) and Supertube (rectangular) duct systems.

To support the system, PVC coated, perforated steel banding is also available for surface mounting or suspending the insulated system. The use of this soft-edged fixing system is strongly recommended to ensure that the insulated duct is held securely without damage.

### Round

Product	Code	Description
	TS1100-4	Ø100mm Round Pipe Duct Insulation 1m
	TS1100-5	Ø125mm Round Pipe Duct Insulation 1m
	TS1100-6	Ø150mm Round Pipe Duct Insulation 1m
	TS490	Ø100mm Round 90° Bend Duct Insulation
	TS590	Ø125mm Round 90° Bend Duct Insulation
	TS690	Ø150mm Round 90° Bend Duct Insulation
	TS491	Ø100mm Round 45° Bend Duct Insulation
	TS591	Ø125mm Round 45° Bend Duct Insulation
	TS691	Ø150mm Round 45° Bend Duct Insulation
	TS492	Ø100mm Round Equal T Piece Duct Insulation
	TS592	Ø125mm Round Equal T Piece Duct Insulation
	TS692	Ø150mm Round Equal T Piece Duct Insulation

### Rectangular

Product	Code	Description
	TS510	204 X 60mm Channel Duct Insulation 1m
	TS910	220 X 90mm Channel Duct Insulation 1m
	TS550	204 X 60mm Horizontal 90° Duct Insulation
	TS950	220 X 90mm Horizontal 90° Duct Insulation
	TS555	204 X 60mm Horizontal 45° Duct Insulation
	TS955	220 X 90mm Horizontal 45° Duct Insulation
	TS582	204 X 60mm Horizontal T Piece Duct Insulation
	TS982	220 X 90mm Horizontal T Piece Duct Insulation
	TS575	204 X 60mm Vertical 45° Bend Duct Insulation
	TS975	220 X 90mm Vertical 45° Bend Duct Insulation
	TS540	204 X 60mm Fixed Spigot Ø125mm Plenum Duct Insulation
	TS961	220 X 90mm Fixed Spigot Ø125mm Plenum Duct Insulation

# ▶ DOMUS ADAPT®



Domus Adapt is a unique duct solution, which will allow for simple, straightforward connection between PCDB (Product Characteristics Database) listed Domus Radial semi-rigid and Domus rigid duct systems with minimal effort.

Designed to lower project costs, whilst also reducing duct installation time by up to 25%; Domus Adapt has innovatively evolved Radial semi-rigid duct systems, to make installing whole house ventilation, easier and more cost effective than ever before.

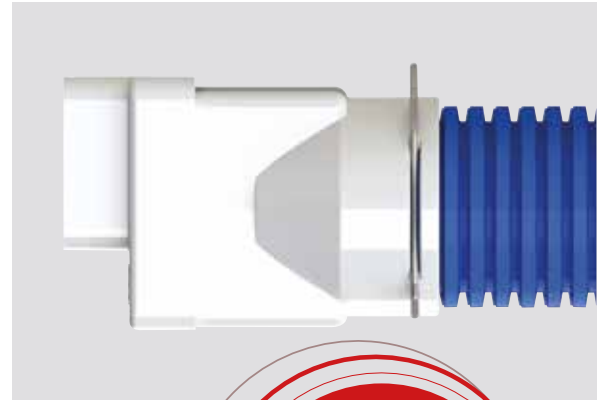

Integrate within your Domus duct system to overcome space restrictions or branch out from your chosen appliance.

## Key features & benefits

- ▶ Lowers project costs.
- ▶ Simplifies installation, to overcome site constraints and space restrictions.
- ▶ Reduces installation time.
- ▶ Allows for a variety of duct configurations.
- ▶ Ideal for apartments or cluster developments, such as care homes and student accommodation\*.
- ▶ Allows installers to run straight into Domus Radial semi-rigid Ø75mm duct; no need for tape, screws or sealant.
- ▶ Provides a complete ducting solution, including the ducting for supply and extract when supporting a kitchen plus two wet rooms.
- ▶ Will remove the need for a manifold; lowering installation costs and time.
- ▶ Helps prevent complicated duct runs, providing simpler design and installation.
- ▶ A versatile solution to help overcome issues associated with a lack of installation space or tight void areas.
- ▶ Domus Radial is a simple plug-and-play, labour saving duct system, which takes away the need for traditional jointing.
- ▶ Manufactured in the UK.

\*Capable of achieving up to 30l/s per fitting.

## Fittings

The Domus Adapt range includes T-pieces, In-line Adapters, Elbows and Bends, available to install with a MVHR or MEV appliance. All pressure loss figures have been tested by the Building Research Establishment (BRE).

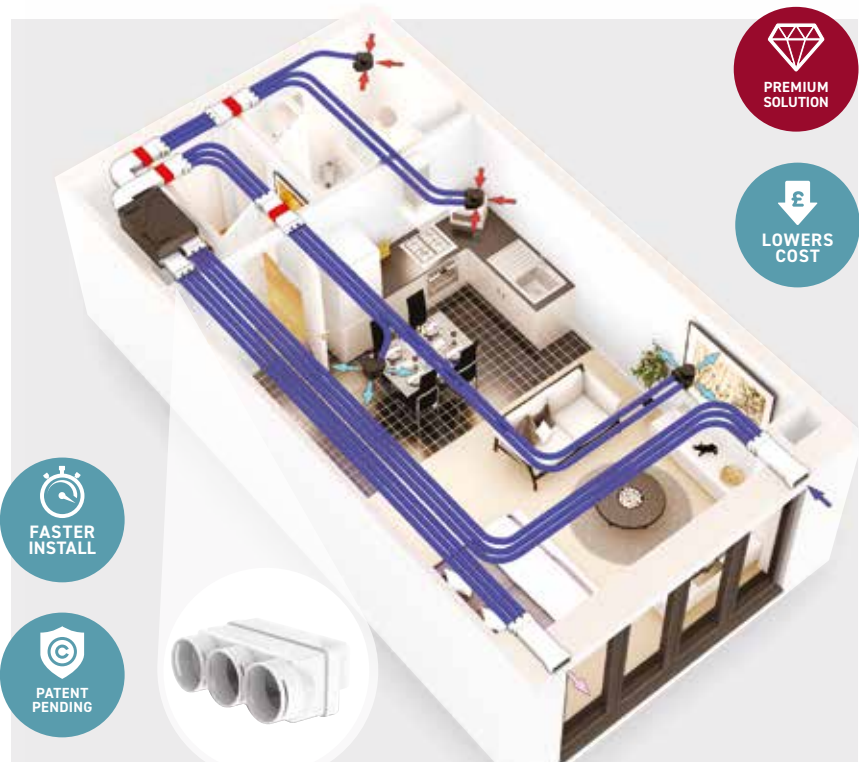

PREMIUM SOLUTION

LOWERS COST

FASTER INSTALL

PATENT PENDING

No typical void space is too tight or duct run too complicated for Domus Adapt, with options available to suit a variety of configurations and installations.

## Mechanical Ventilation with Heat Recovery (MVHR) Range with Domus Adapt

Domus Adapt can be seamlessly installed with the HRX Mechanical Ventilation with Heat Recovery range, allowing fitters to ADAPT straight into Domus Radial duct, thus removing the need for expensive manifolds. All units are available with a Bluebrain Controller, for enhanced user control and air comfort.

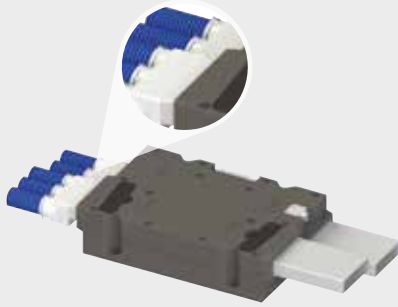

**HRX-aQ**

Ideal for ceiling/void applications in a floor area up to 80m<sup>2</sup>. For more information on unit, see page 21.

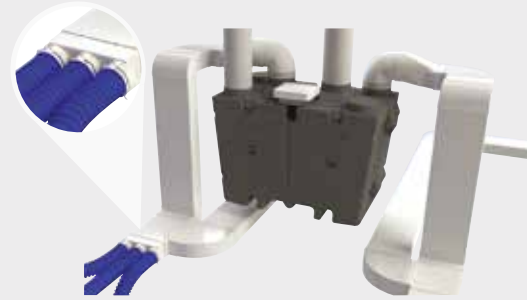

## Mechanical Extract Ventilation (MEV) with Domus Adapt



As a versatile solution, the CMX Mechanical Extract (MEV) appliance is available with Domus Adapt, for a straight in and out Radial duct run.

**Socket Size:** 220x90mm

**Radial Duct Socket Size:** Ø75mm

**Includes:** CMX-S MEV unit, 1 blanking cap, 3 seals and 3 clips

## Fittings

The Domus Adapt range includes T pieces, In-line Adapters, Elbows and Bends, available to install with a MVHR or MEV appliance. All pressure loss figures have been tested by the Building Research Establishment (BRE).

### Adapt T Pieces



RDA-3T, 220x90mm  
RDA-6T, 220x90mm  
RDA-6TB, 220x90mm

### Adapt In-Line Adapters



RDA-3FA, 204x60mm  
RDA-3FC, 220x90mm

### Adapt Elbows



RDA-3R90-125, Ø125mm  
RDA-3R90-150, Ø150mm

### Adapt Horizontal 90° Bend



RDA-3FV90, 220x90mm

### Adapt Vertical 90° Bend



RDA-3FH90, 220x90mm

### Adapt Spares



RDA-CSK3  
RDA-CSK6

### Duct Fire Sleeve



RDA-FSK, 204x60mm

## DOMUS ADAPT T PIECES



Three T-Pieces available in the range which seamlessly incorporate 220x90mm rigid duct and Ø75mm Radial from a centralised mechanical ventilation unit.

### Option 1

Connect into 6 x Ø75mm Domus Radial duct runs.

**Code:** RDA-6T

**T Piece Socket Size:** 220x90mm

**Radial Duct Socket Size:** Ø75mm

**Includes:** 4 blanking caps, 6 clips and 6 seals

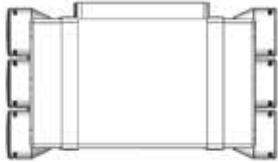

### Option 2

Connect into 6 x Ø75mm Domus Radial duct runs.

**Code:** RDA-6TB

**T Piece Socket Size:** 220x90mm

**Radial Duct Socket Size:** Ø75mm

**Includes:** 4 blanking caps, 6 clips and 6 seals

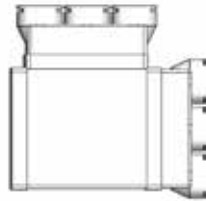

### Option 3

Connect into 3 x Ø75mm Domus Radial duct runs.

**Code:** RDA-3T

**T Piece Socket Size:** 220x90mm

**Radial Duct Socket Size:** Ø75mm

**Includes:** 2 blanking caps, 3 clips and 3 seals

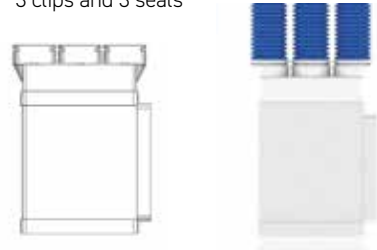

Pressure Drop (Pa)	Airflow Rate (l/s)		
	10.0	20.0	30.0
<b>Supply</b>	1.0	2.7	5.2
<b>Extract</b>	-0.7	-1.4	-2.2

Pressure Drop (Pa)	Airflow Rate (l/s)		
	10.0	20.0	30.0
<b>Supply</b>	1.1	3.3	6.5
<b>Extract</b>	-0.6	-1.1	-1.9

Pressure Drop (Pa)	Airflow Rate (l/s)		
	10.0	20.0	30.0
<b>Supply</b>	0.6	1.5	2.6
<b>Extract</b>	-0.4	-1.0	-1.8

Figures represent a 50% flow rate through the Radial duct.

## DOMUS ADAPT IN-LINE ADAPTERS

### With 3xØ75mm Radial Sockets

This range offers adapters which convert a system's duct from standard uPVC to Domus Ventilation Radial.



### Option 1

Connect into 3 x Ø75mm Domus Radial duct runs.

**Code:** RDA-3FA

**In-line Socket Size:** 204x60mm

**Radial Duct Socket Size:** Ø75mm

**Includes:** 2 blanking caps, 3 clips and 3 seals

Pressure Drop (Pa)	Airflow Rate (l/s)				
	8.0	13.0	15.0	21.0	30.0
<b>Supply</b>	-0.3	-0.2	-0.2	1.6	2.7
<b>Extract</b>	1.0	2.2	2.7	5.3	10.3

### Option 2

Connect into 3 x Ø75mm Domus Radial duct runs.

**Code:** RDA-3FC

**In-line Socket Size:** 220x90mm

**Radial Duct Socket Size:** Ø75mm

**Includes:** 2 blanking caps, 3 clips and 3 seals

Pressure Drop (Pa)	Airflow Rate (l/s)				
	8.0	13.0	15.0	21.0	30.0
<b>Supply</b>	0.1	0.6	1.0	2.2	4.3
<b>Extract</b>	0.6	1.3	1.7	3.5	6.5

## DOMUS ADAPT PLENUM

### With 3xØ75mm Radial Sockets

The plenum, also known as an 'elbow bend' integrates Ø150mm rigid duct with Ø75mm Domus Ventilation Radial in one, straight forward connection with minimal effort. All pressure loss figures have been tested by the Building Research Establishment (BRE).



#### RDA-3R90-125

Connect into 3 x Ø75mm Domus Radial duct runs.

**Elbow Spigot Size:** Ø125mm

**Radial Duct Socket Size:** Ø75mm

**Includes:** 2 blanking caps, 3 clips and 3 seals

Pressure Drop (Pa)	Airflow Rate (l/s)				
	8.0	13.0	15.0	21.0	30.0
<b>Supply</b>	0.5	1.4	1.7	3.7	7.3
<b>Extract</b>	1.5	2.9	3.7	7.2	14.3

#### RDA-3R90-150

Connect into 3 x Ø75mm Domus Radial duct runs.

**Elbow Spigot Size:** Ø150mm

**Radial Duct Socket Size:** Ø75mm

**Includes:** 2 blanking caps, 3 clips and 3 seals

Pressure Drop (Pa)	Airflow Rate (l/s)				
	8.0	13.0	15.0	21.0	30.0
<b>Supply</b>	0.6	1.3	1.8	3.9	7.3
<b>Extract</b>	1.1	1.9	2.3	4.8	9.7

## DOMUS ADAPT HORIZONTAL 90° BEND

### With 3xØ75mm Radial Sockets

The RDA-3FH90 combines 220x90mm PVC and Ø75mm Radial at a 90 horizontal bend.



Connect into 3 x Ø75mm Domus Radial duct runs.

**Code:** RDA-3FH90

**Bend Socket Size:** 220x90mm

**Radial Duct Socket Size:** Ø75mm

**Includes:** 2 blanking caps, 3 clips and 3 seals

Pressure Drop (Pa)	Airflow Rate (l/s)				
	8.0	13.0	15.0	21.0	30.0
<b>Supply</b>	0.3	0.8	1.2	2.7	5.3
<b>Extract</b>	0.7	1.5	1.9	4.1	7.9

## DOMUS ADAPT VERTICAL 90° BEND

### With 3xØ75mm Radial Sockets

The RDA-3FV90 combines 220x90mm PVC and Ø75mm Radial at a 90 vertical bend.



Connect into 3 x Ø75mm Domus Radial duct runs.

**Code:** RDA-3FV90

**Bend Socket Size:** 220x90mm

**Radial Duct Socket Size:** Ø75mm

**Includes:** 2 blanking caps, 3 clips and 3 seals

Pressure Drop (Pa)	Airflow Rate (l/s)				
	8.0	13.0	15.0	21.0	30.0
<b>Supply</b>	0.4	1.0	1.4	3.2	5.6
<b>Extract</b>	0.7	1.6	2.0	4.2	8.3

## DOMUS ADAPT SPARES PACK

### Blanking Plates, Clips and Seals

Whilst 'House Packs' are available, which provides an estimated system requirement for average plots, Domus Ventilation also offer Spares Packs which ensure you have enough fixings on-site, at a minimal cost.



#### Option 1

**Code:** RDA-CSK3

**Includes:** 2 blanking caps, 3 clips and 3 seals

#### Option 2

**Code:** RDA-CSK6

**Includes:** 4 blanking caps, 6 clips and 6 seals

## DOMUS ADAPT FIRE SLEEVE KIT

The RDA-FSK is a Fire Sleeve designed specifically for use with the Adapt range and exceeds all Fire Regulations needed for both new-build and refurb projects. It is quick and easy to install. Please contact us for availability of other sizes.



**Code:** RDA-FSK

**Size:** 204x60mm

# ► FIRE SLEEVES

Domus Ventilation offers fire solutions to prevent the spread of fire where rigid ducting penetrates fire compartment walls.

All Domus Ventilation plastic ductwork will meet **UL94VO (duct)** and **UL94HB (fittings)** flammability standard.

For installation and technical information visit: [www.tenmat.com](http://www.tenmat.com)

## FIRE SLEEVES – HORIZONTAL

### Key features

- Can be retro fitted.
- Low profile design.
- Available preformed and ready to install in both circular or rectangular shapes.
- Compressible material, offers accommodation for deflection.



Product code	Description	Duct size	Length
FBS20460H	Duct Fire Sleeve: FF109	204 x 60mm	150mm
FBS22090H	Duct Fire Sleeve: FF109	220 x 90mm	150mm



Product code	Description	Duct size	Length
FBS100H	Duct Fire Sleeve: FF109	Ø100mm	150mm
FBS125H	Duct Fire Sleeve: FF109	Ø125mm	250mm



# FIRE RATED CEILING AIR VALVES

## Product overview

Recessed ceiling air valves are widely used in both domestic and commercial buildings. Ceilings must be fire protected in accordance with Approved Document B of the Building Regulations 2021.

Once a hole is made in a ceiling for an air valve, the integrity of the construction and its ability to perform in a fire is reduced significantly. This must be fire-stopped to reinstate the original fire rating of the ceiling.

The popularity of whole-house ventilation and controlled ventilation is increasing. This results in an increased number of penetrations through fire compartment walls and floors producing open pathways for the passage of both smoke and fire.

Ceiling air valves, if left unprotected, can allow a fire to spread rapidly through a building.

## Key features

- ▶ Meet the requirement of Building Regulations Approved Document B.
- ▶ Maintains integrity of fire rated ceilings for up to 60 minutes.
- ▶ Alternative to more expensive fire dampers.
- ▶ Fits in exactly the same way as a standard metal air valve.
- ▶ Air flow is unaffected.
- ▶ Easy to retrofit in place of existing metal air valves.
- ▶ Highly cost effective.



## Fire testing

Successfully tested for 60 minutes according to BS EN 1365-2:1999 & BS 476  
Test report number: BTC 18074F

## Dimensions

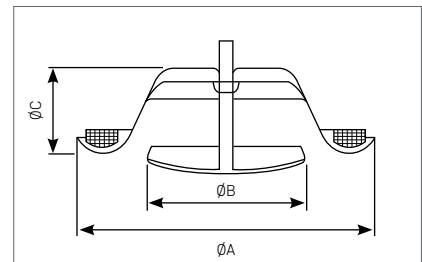

Product code	Duct size	A (mm)	B (mm)	C (mm)	Weight (kg)
136FR-24M	Ø100mm	140	75	40	0.16
136FR-25M	Ø125mm	170	99	46	0.23
136FR-26M	Ø150mm	202	119	54	0.34

### 136FR-25M (EXTRACT) AIR RESISTANCE

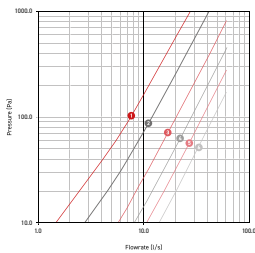

### 136FR-25M (SUPPLY) AIR RESISTANCE

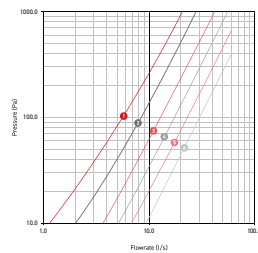

### 136FR-26M (EXTRACT) AIR RESISTANCE

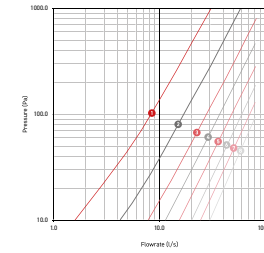

### 136FR-26M (SUPPLY) AIR RESISTANCE

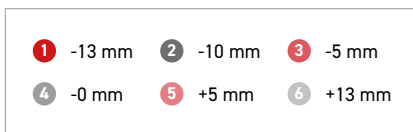
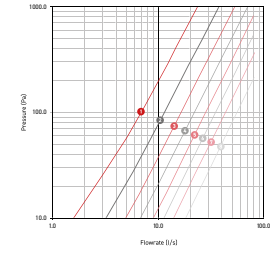

This performance data is displayed using the logarithmic format. Each line represents the valve's displacement from its neutral position where the base of the valve is in line with the edge of the outer ring. Minimum displacement value is fully closed, maximum is fully open.

\*100mm can be provided on request

# ▶ GRILLES AND EXTERNAL GRILLES

We offer a wide range of stylish architectural grilles for internal and external use.













Where fittings are available in different colours:



Colour	RAL Reference and Title		Colour	RAL Reference and Title	
○ White	Traffic White	RAL 9016	● Terracotta	Copper Brown	RAL 8004
● Brown	Nut Brown	RAL 8011	● Black	Traffic Black	RAL 9017
○ Cotswold	Ivory	RAL 1014	● Grey	Telegrey 2	RAL 7046



## EXTERNAL WALL DUCT TERMINALS

### 110x54mm System

	Code	Description	Colour	Size (mm)	Connection
	4901B	Rigid Duct Outlet with Gravity Flaps	Brown	H155xW155xD30	Male
	4901C	Rigid Duct Outlet with Gravity Flaps	Cotswold	H155xW155xD30	Male
	4901T	Rigid Duct Outlet with Gravity Flaps	Terracotta	H155xW155xD30	Male
	4903W	Rigid Duct Outlet Cowled with Damper	White	H155xW155xD100	Male
	4903B	Rigid Duct Outlet Cowled with Damper	Brown	H155xW155xD100	Male
	4905W	Rigid Duct Outlet Louvered Grille	White	H155xW155xD40	Male
	4905B	Rigid Duct Outlet Louvered Grille	Brown	H155xW155xD40	Male
	4905C	Rigid Duct Outlet Louvered Grille	Cotswold	H155xW155xD40	Male
	4905T	Rigid Duct Outlet Louvered Grille	Terracotta	H155xW155xD40	Male
	F4905W	Rigid Duct Outlet Louvered Grille with Flyscreen	White	H155xW155xD40	Male
	F4905B	Rigid Duct Outlet Louvered Grille with Flyscreen	Brown	H155xW155xD40	Male
	F4905C	Rigid Duct Outlet Louvered Grille with Flyscreen	Cotswold	H155xW155xD40	Male

**Why metal external AirBricks?** This has been brought in owing to legislation changes, Part B fire regulations have recently changed and now confirm that no combustible material i.e. pvc is to be installed within or on external surface of an external wall above 11m in Scotland and above 18m in England and Wales, therefore, giving us no option but to design and manufacture a metal version.















**204x60mm System**

	Code	Description	Colour	Size (mm)	Connection
	55015W	Rigid Duct Outlet Airbrick with Damper and Wall Plate	White	H69xW210xD56	Male
	55015B	Rigid Duct Outlet Airbrick with Damper and Wall Plate	Brown	H69xW210xD56	Male

**220x90mm System**











	Code	Description	Colour	Size (mm)	Connection
	977	Rigid Duct In-Line Adapter Rectangular-Rectangular	White	H133xW227xD52	Female/Male

**Ø100mm System**











	Code	Description	Colour	Size (mm)	Connection
	4900G	Rigid Duct Outlet with Gravity Flaps	Grey	H155xW155xD30	Male
	4900B	Rigid Duct Outlet with Gravity Flaps	Brown	H155xW155xD30	Male
	4900C	Rigid Duct Outlet with Gravity Flaps	Cotswold	H155xW155xD30	Male
	4900T	Rigid Duct Outlet with Gravity Flaps	Terracotta	H155xW155xD30	Male
	4900BK	Rigid Duct Outlet with Gravity Flaps	Black	H155xW155xD30	Male
	4902W	Rigid Duct Outlet Cowled with Damper	White	H155xW155xD100	Male
	4902G	Rigid Duct Outlet Cowled with Damper	Grey	H155xW155xD100	Male
	4902B	Rigid Duct Outlet Cowled with Damper	Brown	H155xW155xD100	Male
	4902C	Rigid Duct Outlet Cowled with Damper	Cotswold	H155xW155xD100	Male
	4902T	Rigid Duct Outlet Cowled with Damper	Terracotta	H155xW155xD100	Male
	4902BK	Rigid Duct Outlet Cowled with Damper	Black	H155xW155xD100	Male
	4804W	Rigid Duct Outlet Louvered Soffit Vent	White	H122xW122xD27	Male
	4804B	Rigid Duct Outlet Louvered Soffit Vent	Brown	H122xW122xD27	Male
	F4804W	Rigid Duct Outlet Louvered Soffit Vent with Flyscreen	White	H122xW122xD27	Male
	F4804B	Rigid Duct Outlet Louvered Soffit Vent with Flyscreen	Brown	H122xW122xD27	Male

**Why metal external AirBricks?** This has been brought in owing to legislation changes, Part B fire regulations have recently changed and now confirm that no combustible material i.e. pvc is to be installed within or on external surface of an external wall above 11m in Scotland and above 18m in England and Wales, therefore, giving us no option but to design and manufacture a metal version.

**Ø125mm System**

	Code	Description	Colour	Size (mm)	Connection
	5900G	Rigid Duct Outlet with Gravity Flaps	Grey	H155xW155xD30	Male
	5900B	Rigid Duct Outlet with Gravity Flaps	Brown	H155xW155xD30	Male
	5900C	Rigid Duct Outlet with Gravity Flaps	Cotswold	H155xW155xD30	Male
	5900T	Rigid Duct Outlet with Gravity Flaps	Terracotta	H155xW155xD30	Male
	5902W	Rigid Duct Outlet Cowled with Damper	White	H155xW155xD100	Male
	5902G	Rigid Duct Outlet Cowled with Damper	Grey	H155xW155xD100	Male
	5902B	Rigid Duct Outlet Cowled with Damper	Brown	H155xW155xD100	Male
	5902C	Rigid Duct Outlet Cowled with Damper	Cotswold	H155xW155xD100	Male
	5902T	Rigid Duct Outlet Cowled with Damper	Terracotta	H155xW155xD100	Male

**Ø150mm System**

	Code	Description	Colour	Size (mm)	Connection
	6900G	Rigid Duct Outlet with Gravity Flaps	Grey	H155xW155xD30	Male
	6900B	Rigid Duct Outlet with Gravity Flaps	Brown	H155xW155xD30	Male
	6900C	Rigid Duct Outlet with Gravity Flaps	Cotswold	H155xW155xD30	Male
	6900T	Rigid Duct Outlet with Gravity Flaps	Terracotta	H155xW155xD30	Male
	6902W	Rigid Duct Outlet Cowled with Damper	White	H155xW155xD100	Male
	6902G	Rigid Duct Outlet Cowled with Damper	Grey	H155xW155xD100	Male
	6902B	Rigid Duct Outlet Cowled with Damper	Brown	H155xW155xD100	Male
	6902C	Rigid Duct Outlet Cowled with Damper	Cotswold	H155xW155xD100	Male
	6902T	Rigid Duct Outlet Cowled with Damper	Terracotta	H155xW155xD100	Male

**Why metal external AirBricks?** This has been brought in owing to legislation changes, Part B fire regulations have recently changed and now confirm that no combustible material i.e. pvc is to be installed within or on external surface of an external wall above 11m in Scotland and above 18m in England and Wales, therefore, giving us no option but to design and manufacture a metal version.

## EXTERNAL ROOF DUCT TERMINALS



Also available  
in Terracotta

### Design and performance

The Universal Service Terminal is suitable for use in all tiled and slated pitched roof styles without the need to identify the make or design of the tiles or slates. The unit comprises a flat box hood on a circular upstand, a 500mm x 500mm flashing skirt of non-lead material and a stepped adapter that allows connection to 100mm, 110mm, 125mm, 150mm and 160mm ventilation pipe. This unit can also be used to vent soil and vent pipes where an external pressure test is not required.

The free areas and pressure/airflow readings are as follows:

Code	Colour	Connection
4411	Black	Male
4411T	Terracotta	Male

Diameter (mm)	Free vent area (mm <sup>2</sup> )	Pressure/Airflow Resistance (pa)	
		100m <sup>3</sup> /hr	200m <sup>3</sup> /hr
100	7,850	3.0	7.5
110	8,850	4.5	16.0
125	12,250	5.3	24.0
150	17,775	6.5	31.0
160	18,750	6.5	31.0

### Key features and benefits

- ▶ Large diameter spigot c/w Adapter to accept ducting of 100/110/125/150/160mm.
- ▶ 20,000mm<sup>2</sup> large free vent area.

### Roof finish

- ▶ Suitable for most tiled and slated pitched roofs
- ▶ **Not suitable for flat roof application**

The unit is easy to install – the adapter is simply cut at the required diameter step and attached to the undertile spigot with solvent weld/PVC glue. The flashing material allows fitting into most tiles and slates.

### Material

- ▶ Flashing skirt manufactured from non-lead material
- ▶ Terminal, Box and Adapter manufactured from UPVC and Ubiflex

# SOLIS AirBrick™

## LOW RESISTANCE METAL AIRBRICK

The Domus Ventilation Solis AirBrick has been designed as a non-combustible AirBrick to maintain low resistance and comply with the latest standards set out in Approved Document B (fire safety).

The range consists of three versions: 204x60, 220x90 and 220x126 to accommodate all external wall types.



### Key features

- ▶ Non-combustible as set out in Approved Document B (fire safety)
- ▶ 204x60, 220x90 and 220x126 options.
- ▶ Low resistance.
- ▶ Compatible with Domus Rigid and Thermal ducting range.
- ▶ AirBrick powder coating pre-qualified to EN13501-1 classification A2-s1,d0.
- ▶ AirBrick material 1.5mm galvanised steel, fire class A1 'no contribution to fire'.
- ▶ Metal air duct material 0.8mm galvanised steel, fire class A1 'no contribution to fire'.

### CIBSE CPD

- ▶ With the changes in Building Regulations, Domus Ventilation offers a FREE CIBSE approved CPD which runs through Building Regulations and how the new non-combustible AirBrick can integrate into your projects. Contact us for more information.

### Product Codes

Product Codes	Description
SOL-AB-204X60W	204x60mm Single Metal AirBrick White
SOL-AB-220X90W	220x90mm Single Metal AirBrick White
SOL-AB-220X126W	220x126mm Single Metal AirBrick White
SOL-DUCT-204X60	204X60mm Metal Sleeve 550mm
SOL-DUCT-220X90	220x90mm Metal Sleeve 550mm
SOL-DUCT-220X126	220x126mm Metal Sleeve 550mm



#### Description

LOW RESISTANCE METAL AIRBRICK, 204X60 (SUPPLY)  
 LOW RESISTANCE METAL AIRBRICK, 204X60 (EXHAUST)

**Note:** Supply Data based on Test Report No. TB2329. Exhaust Data based on Test Report No. TB2332.

#### Approximate Free Area Space

SOL-AB-204X60 – 8,760mm<sup>2</sup>

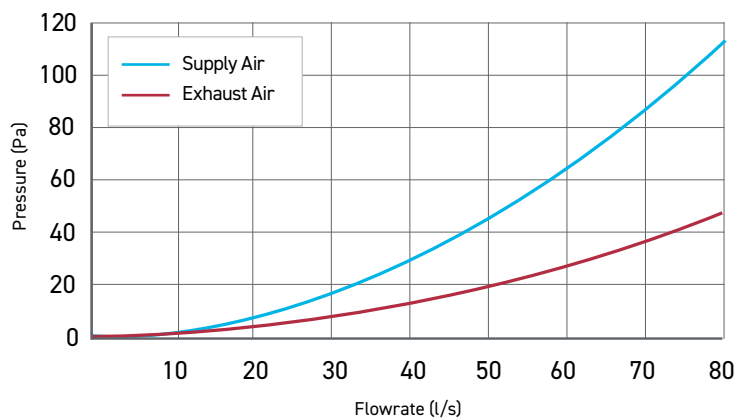

**Note:** Performance testing carried out using BS EN 1314

Performance data								
Flowrate (l/s)	10	20	30	40	50	60	70	80
Pressure (Pa) - (Supply)	2.1	7.7	16.9	29.8	46.3	66.4	90.1	117.5
Pressure (Pa) - (Exhaust)	1.3	4.1	8.3	13.9	20.9	29.2	39.0	50.1

## LOW RESISTANCE METAL AIRBRICK | 220X90



### Description

LOW RESISTANCE METAL AIRBRICK,  
220X90 (SUPPLY)  
LOW RESISTANCE METAL AIRBRICK,  
220X90 (EXHAUST)

**Note:** Supply Data based on Test Report No. TB2328. Exhaust Data based on Test Report No. TB2333.

### Approximate Free Area Space

SOL-AB-220X90 - 14,820mm<sup>2</sup>

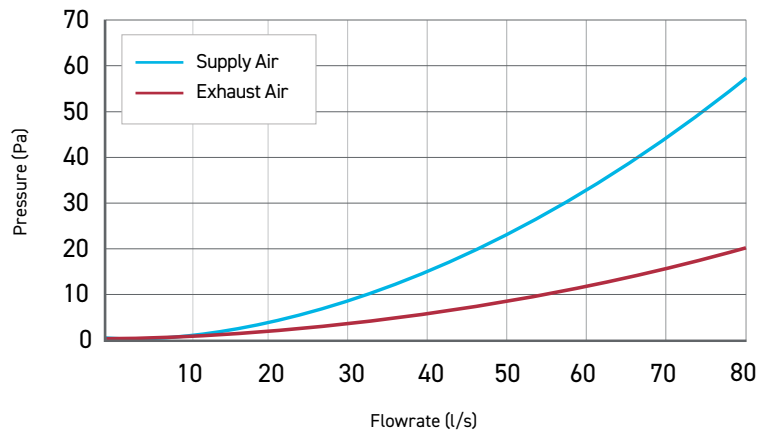

**Note:** Performance testing carried out using BS EN 13141-2.

Performance data								
Flowrate (l/s)	10	20	30	40	50	60	70	80
Pressure (Pa) - (Supply)	1.0	4.0	9.0	15.9	24.7	35.5	48.2	62.9
Pressure (Pa) - (Exhaust)	1.1	2.3	4.1	6.5	9.5	13.0	17.1	21.9

## LOW RESISTANCE METAL AIRBRICK | 220X126



### Description

LOW RESISTANCE METAL AIRBRICK,  
220X126 (SUPPLY)  
LOW RESISTANCE METAL AIRBRICK,  
220X126 (EXHAUST)

**Note:** Supply Data based on Test Report No. TB2327. Exhaust Data based on Test Report No. TB2334.

### Approximate Free Area Space

SOL-AB-220X126 - 21,253mm<sup>2</sup>

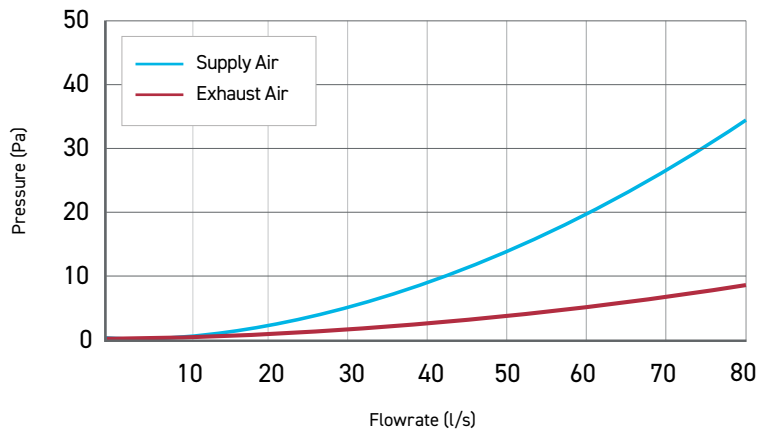

**Note:** Performance testing carried out using BS EN 13141-2.

Performance data								
Flowrate (l/s)	10	20	30	40	50	60	70	80
Pressure (Pa) - (Supply)	0.7	2.6	5.5	9.7	15.0	21.4	29.0	37.8
Pressure (Pa) - (Exhaust)	0.2	0.8	1.6	2.7	4.1	5.7	7.5	9.6

## Dimensions (mm)



### 204X60

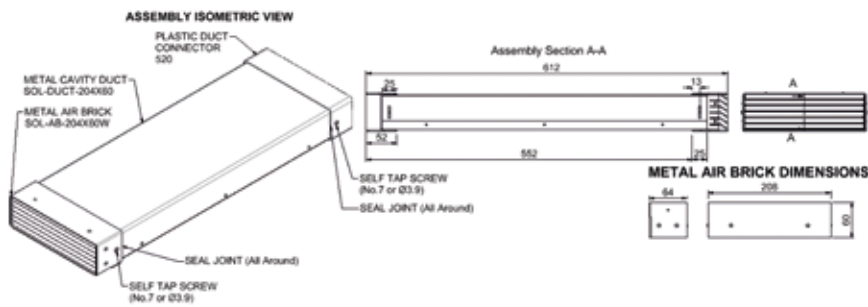

### 220X90

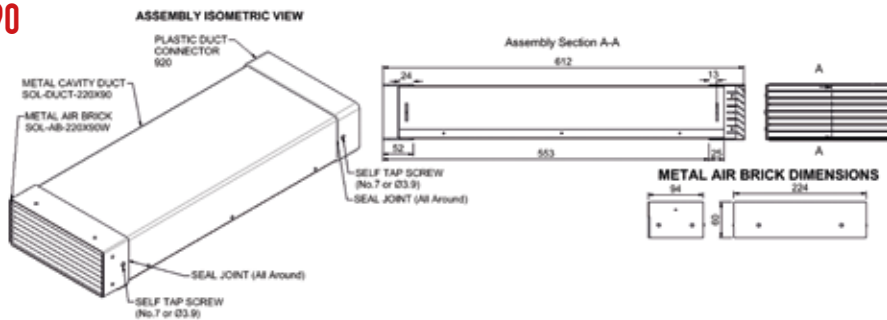

### 220X126

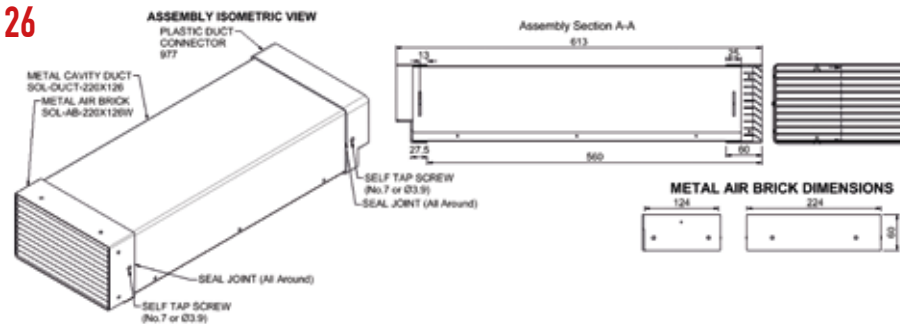

All items are to be purchased separately. Assembly to be carried out on site by installer.

The colour options are applicable to the low resistance metal AirBricks only.

## WE'RE THE UK'S NO1 FOR DUCTING

Domus Ventilation is the complete solution provider of duct and accessories, offering guaranteed compatibility, compliant with regulations, quality of fit and peace of mind!

- ▶ Rigid duct
- ▶ Flexi duct
- ▶ Radial duct
- ▶ Thermal duct
- ▶ Tape, sealant and screws

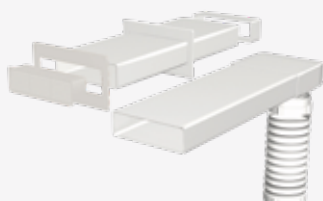

## CIBSE CPD

- ▶ With the changes in building regulations, Domus Ventilation offers a FREE CIBSE approved CPD which runs through building regulations and how the new non-combustible AirBrick can integrate into your projects. Contact us for more information.

Colour	RAL Reference and Title	
	White	Traffic White RAL 9016
	Brown	Nut Brown RAL 8011
	Cotswold	Ivory RAL 1014
Colour	RAL Reference and Title	
	Terracotta	Copper Brown RAL 8004
	Black	Traffic Black RAL 9017
	Grey	Telegrey 2 RAL 7046

**Need a bespoke colour?** Just send us the RAL number and we can do this for you!



# SOLIS AirBrick™ with Bezel



## LOW RESISTANCE METAL AIRBRICK

The Domus Ventilation Solis AirBrick with Bezel has been designed as a non-combustible AirBrick to maintain low resistance and comply with the latest standards set out in Approved Document B (fire safety).

The range consists of three sizes: 204x60, 220x90 and 220x126 to accommodate all external wall types.

### Key features

- ▶ Non-combustible as set out in Approved Document B (fire safety).
- ▶ 204x60, 220x90 and 220x126 options.
- ▶ Low resistance.
- ▶ Compatible with Domus Rigid and Thermal ducting range.
- ▶ AirBrick powder coating pre-qualified to EN13501-1 classification A2-s1,d0.
- ▶ AirBrick material 1.5mm galvanized steel, fire Class A1 'no contribution to fire'.
- ▶ Metal air duct material 0.8mm galvanised steel, fire Class A1 'no contribution to fire'.

### Product Codes

Unit Code	Description
SOL-AB-204x60	204x60mm Single Metal AirBrick
SOL-AB-220x90	220x90mm Single Metal AirBrick
SOL-AB-204x126	204x6126mm Single Metal AirBrick
SOL-AB-204x60-B	204x60mm Single Metal AirBrick with Bezel
SOL-AB-220x90-B	220x90mm Single Metal AirBrick with Bezel
SOL-AB-204x126-B	204x60mm Single Metal AirBrick with Bezel

### CIBSE CPD

- ▶ With the changes in Building Regulations, Domus Ventilation offers a FREE CIBSE approved CPD which runs through Building Regulations and how the new non-combustible AirBrick can integrate into your projects. Contact us for more information.



## LOW RESISTANCE METAL AIRBRICK | 204X60



#### Description

LOW RESISTANCE METAL AIRBRICK, 204X60 (SUPPLY)  
 LOW RESISTANCE METAL AIRBRICK, 204X60 (EXHAUST)

Note: Supply Data based on Test Report No. TB2329. Exhaust Data based on Test Report No. TB2332.

#### Approximate Free Area Space

SOL-AB-204X60 - 8,760mm<sup>2</sup>

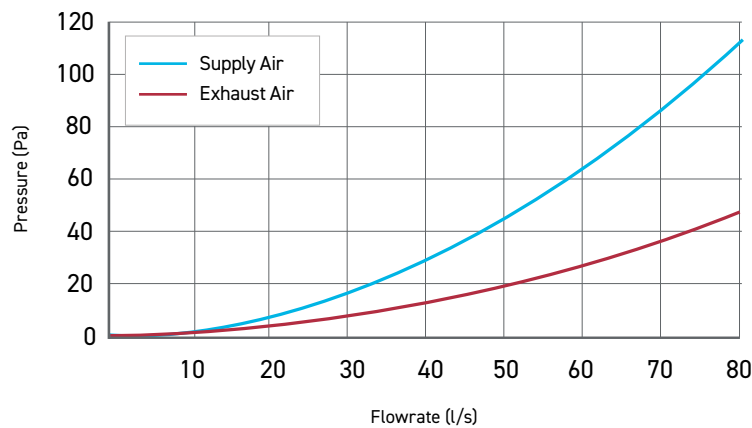

Note: Performance testing carried out using BS EN 13141-2.

Performance data								
Flowrate (l/s)	10	20	30	40	50	60	70	80
Pressure (Pa) - (Supply)	2.1	7.7	16.9	29.8	46.3	66.4	90.1	117.5
Pressure (Pa) - (Exhaust)	1.3	4.1	8.3	13.9	20.9	29.2	39.0	50.1

## LOW RESISTANCE METAL AIRBRICK | 220X90



### Description

LOW RESISTANCE METAL AIRBRICK,  
220X90 (SUPPLY)  
LOW RESISTANCE METAL AIRBRICK,  
220X90 (EXHAUST)

**Note:** Supply Data based on Test Report No. TB2328. Exhaust Data based on Test Report No. TB2333.

### Approximate Free Area Space

SOL-AB-220X90 – 14,820mm<sup>2</sup>

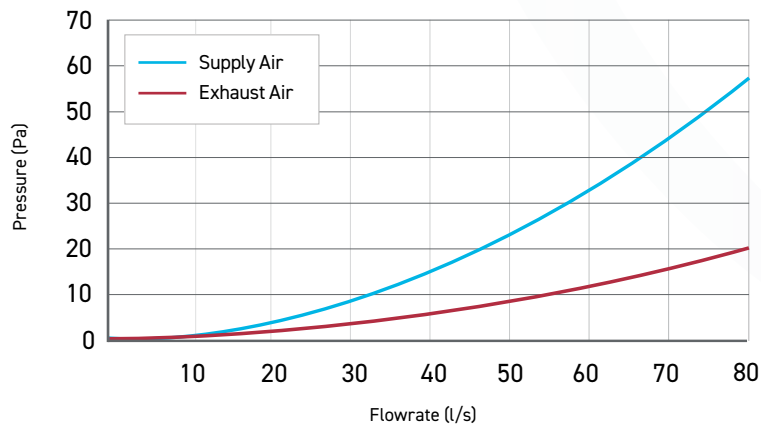

**Note:** Performance testing carried out using BS EN 13141-2.

Performance data								
Flowrate (l/s)	10	20	30	40	50	60	70	80
Pressure (Pa) - (Supply)	1.0	4.0	9.0	15.9	24.7	35.5	48.2	62.9
Pressure (Pa) - (Exhaust)	1.1	2.3	4.1	6.5	9.5	13.0	17.1	21.9

## LOW RESISTANCE METAL AIRBRICK | 220X126



### Description

LOW RESISTANCE METAL AIRBRICK,  
220X126 (SUPPLY)  
LOW RESISTANCE METAL AIRBRICK,  
220X126 (EXHAUST)

**Note:** Supply Data based on Test Report No. TB2327. Exhaust Data based on Test Report No. TB2334.

### Approximate Free Area Space

SOL-AB-220X126 – 21,253mm<sup>2</sup>

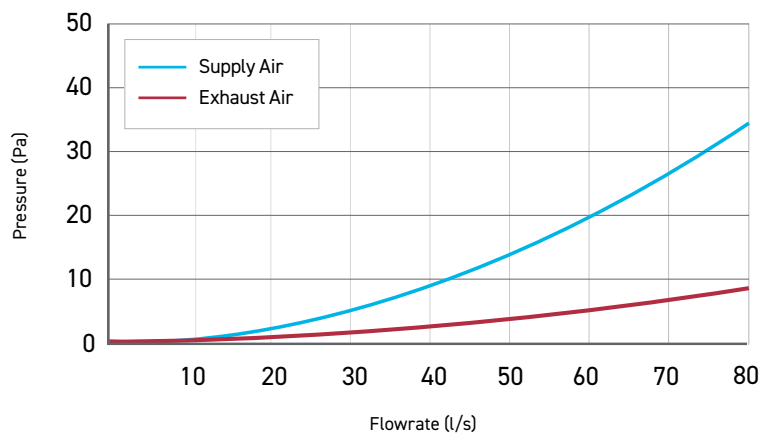

**Note:** Performance testing carried out using BS EN 13141-2.

Performance data								
Flowrate (l/s)	10	20	30	40	50	60	70	80
Pressure (Pa) - (Supply)	0.7	2.6	5.5	9.7	15.0	21.4	29.0	37.8
Pressure (Pa) - (Exhaust)	0.2	0.8	1.6	2.7	4.1	5.7	7.5	9.6

Dimensions (mm)



204X60

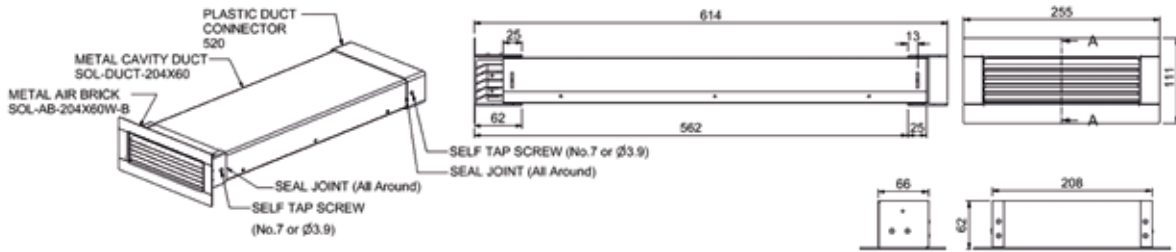

220X90

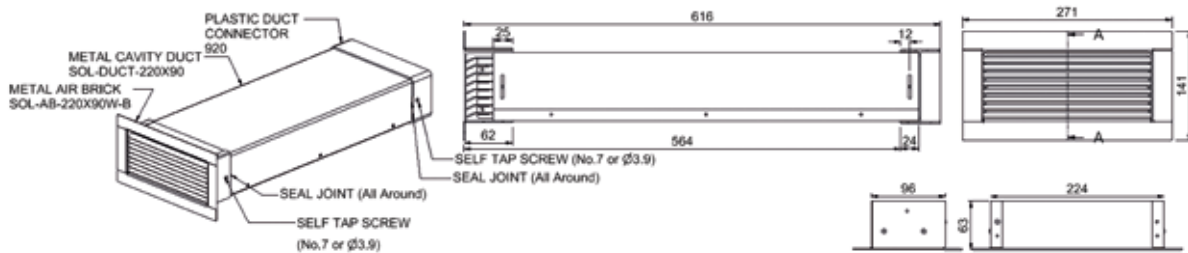

220X126

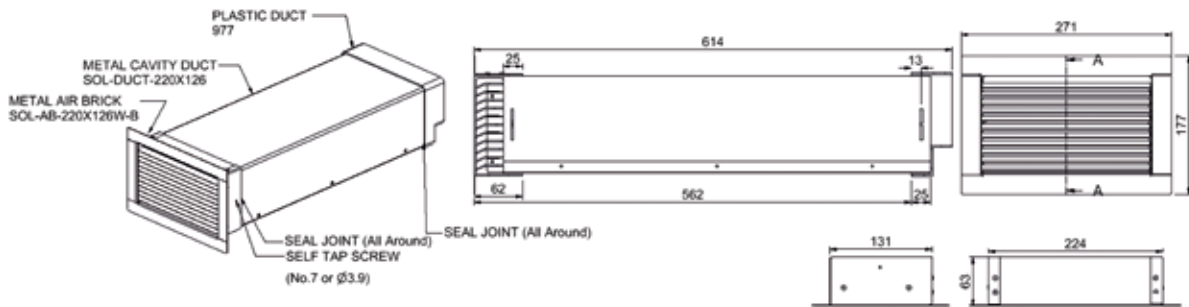

WE'RE THE UK'S N01 FOR DUCTING

Domus Ventilation is the complete solution provider of duct and accessories, offering guaranteed compatibility, compliant with regulations, quality of fit and peace of mind.

- ▶ Rigid duct
- ▶ Flexi duct
- ▶ Radial duct
- ▶ Thermal duct
- ▶ Tape, sealant and screws

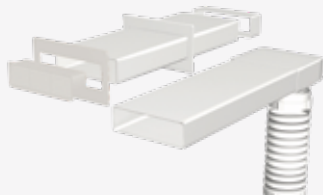

The colour options are applicable to the low resistance metal AirBricks only.

Colour	RAL Reference and Title	
	White	Traffic White RAL 9016
	Brown	Nut Brown RAL 8011
	Cotswold	Ivory RAL 1014
Colour	RAL Reference and Title	
	Terracotta	Copper Brown RAL 8004
	Black	Traffic Black RAL 9017
	Grey	Telegrey 2 RAL 7046

**Need a bespoke colour?** Just send us the RAL number and we can do this for you!

# ▶ PLASTIC AIRBRICKS

501



## Description

- ▶ AirBrick with Damper, 204mm x 60mm spigot (male)
- ▶ Exhaust (air to atmosphere)

## Material

- ▶ HIPS (High Impact Polystyrene)

## Colour

- ▶ White (RAL9016)
- ▶ Brown (RAL8011)
- ▶ Terracotta (RAL8004)
- ▶ Cotswold (RAL1014)
- ▶ Grey (RAL7046)
- ▶ Black (RAL9017)

## Exhaust



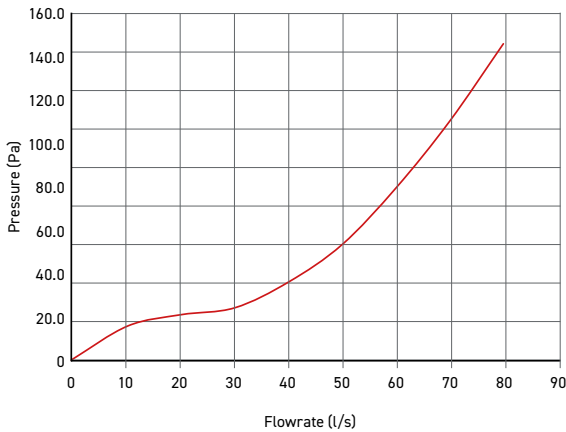

Cubic equation to derive pressure drop =  $-0.00001x^4 + 0.00189x^3 - 0.09182x^2 + 2.13221x + 0.28310$



### Performance data

Airflow I' (l/s)	0	10	20	30	40	50	60	70	80
Pressure Drop (Pa)	0	14.9	20	23.1	34.8	51.7	77.3	107.4	142.4

Performance data from Test Report TR1622

	Code	Description	Colour	Size (mm)	Connection
	501W	Rigid Duct Outlet AirBrick with Damper	White	H69xW210xD56	Male
	501G	Rigid Duct Outlet AirBrick with Damper	Grey	H69xW210xD56	Male
	501B	Rigid Duct Outlet AirBrick with Damper	Brown	H69xW210xD56	Male
	501C	Rigid Duct Outlet AirBrick with Damper	Cotswold	H69xW210xD56	Male
	501T	Rigid Duct Outlet AirBrick with Damper	Terracotta	H69xW210xD56	Male

**Why metal external AirBricks?** This has been brought in owing to legislation changes, Part B fire regulations have recently changed and now confirm that no combustible material i.e. pvc is to be installed within or on external surface of an external wall above 11m in Scotland and above 18m in England and Wales, therefore, giving us no option but to design and manufacture a metal version.

# 505



## Description

- ▶ AirBrick with 204mm x 60mm spigot (female)
- ▶ Exhaust (air to atmosphere)
- ▶ Intake (air from atmosphere)

## Material

- ▶ HIPS (High Impact Polystyrene)

## Colour

- ▶ White (RAL9016)
- ▶ Brown (RAL8011)
- ▶ Terracotta (RAL8004)
- ▶ Cotswold (RAL1014)
- ▶ Grey (RAL7046)
- ▶ Black (RAL9017)

### Exhaust

Cubic equation to derive pressure drop  
 $= -0.00009x^3 + 0.03904x^2 - 0.15301x + 0.58185$

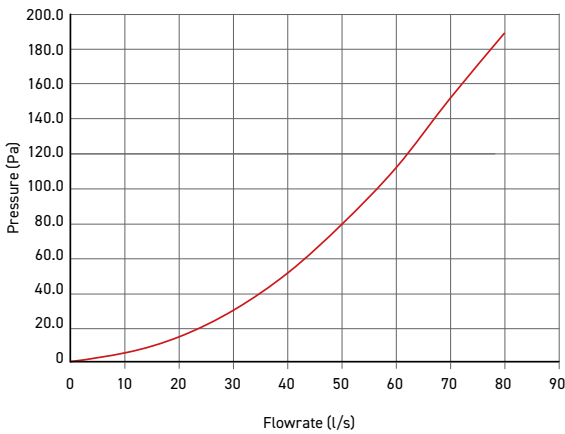

### Intake

Cubic equation to derive pressure drop  
 $= -0.00001x^3 + 0.03584x^2 + 0.02552x - 0.16330$

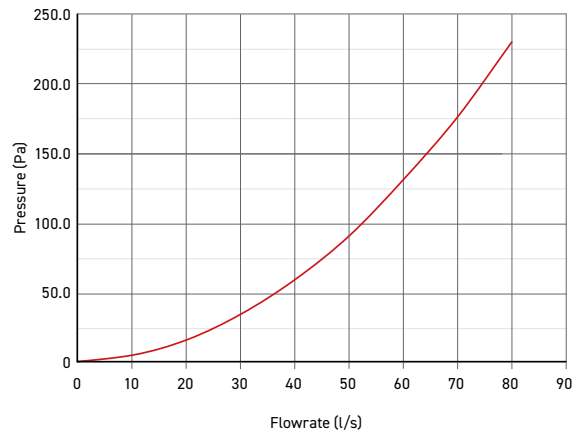

Performance data									
Airflow V' (l/s)	0	10	20	30	40	50	60	70	80
Pressure Drop (Pa)	0	3.6	13	28.4	50.1	81.2	111.0	151.1	188.7

Performance data									
Airflow V' (l/s)	0	10	20	30	40	50	60	70	80
Pressure Drop (Pa)	0	3.4	14.5	33.0	58.0	89.3	129.8	174.6	228.3

Performance data from Test Report TR1622

	Code	Description	Colour	Size (mm)	Connection
	505W	Rigid Duct Outlet AirBrick	White	H70xW210xD62	Female
	505B	Rigid Duct Outlet AirBrick	Brown	H70xW210xD62	Female
	505C	Rigid Duct Outlet AirBrick	Cotswold	H70xW210xD62	Female
	505T	Rigid Duct Outlet AirBrick	Terracotta	H70xW210xD62	Female
	505BK	Rigid Duct Outlet AirBrick	Black	H70xW210xD62	Female
	505G	Rigid Duct Outlet AirBrick	Grey	H70xW210xD62	Female

**Why metal external AirBricks?** This has been brought in owing to legislation changes, Part B fire regulations have recently changed and now confirm that no combustible material i.e. pvc is to be installed within or on external surface of an external wall above 11m in Scotland and above 18m in England and Wales, therefore, giving us no option but to design and manufacture a metal version.

# 905



## Description

- ▶ Double AirBrick with 220mm x 90mm spigot (female)
- ▶ Exhaust (air to atmosphere)  
977 adapter on end of ducting to 905B
- ▶ Intake (air from atmosphere)  
977 adapter on end of ducting to 905B

## Material

- ▶ HIPS (High Impact Polystyrene)

## Colour

- ▶ White (RAL9016)
- ▶ Brown (RAL8011)
- ▶ Terracotta (RAL8004)
- ▶ Cotswold (RAL1014)
- ▶ Grey (RAL7046)
- ▶ Black (RAL9017)

## Exhaust

Cubic equation to derive pressure drop  
 $= 0.0011x^2 - 0.0117x + 0.0895$

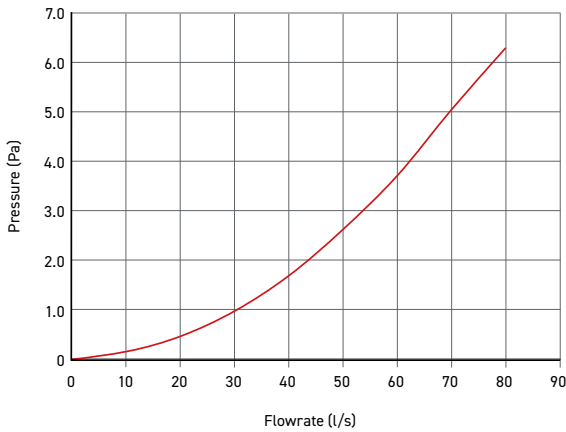

## Intake

Cubic equation to derive pressure drop  
 $= 0.0057x - 0.0044$

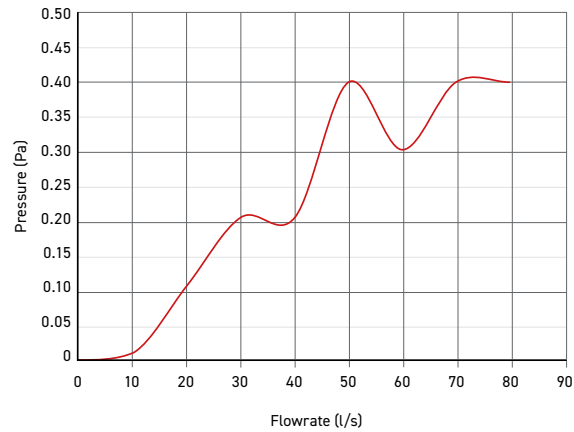

Performance data									
Airflow V' (l/s)	0	10	20	30	40	50	60	70	80
Pressure Drop (Pa)	0	0.1	0.4	0.8	1.4	2.2	3.2	4.6	6.3

Performance data									
Airflow V' (l/s)	0	10	20	30	40	50	60	70	80
Pressure Drop (Pa)	0	0	0.1	0.2	0.2	0.4	0.3	0.4	0.4

Performance data from Test Report TR1622

	Code	Description	Colour	Size (mm)	Connection
	905W	Rigid Duct Outlet AirBrick Double	White	H140xW250xD75	Female
	905B	Rigid Duct Outlet AirBrick Double	Brown	H140xW250xD75	Female
	905C	Rigid Duct Outlet AirBrick Double	Cotswold	H140xW250xD75	Female
	905T	Rigid Duct Outlet AirBrick Double	Terracotta	H140xW250xD75	Female
	905BK	Rigid Duct Outlet AirBrick Double	Black	H140xW250xD75	Female
	905G	Rigid Duct Outlet AirBrick Double	Grey	H140xW250xD75	Female

**Why metal external AirBricks?** This has been brought in owing to legislation changes, Part B fire regulations have recently changed and now confirm that no combustible material i.e. pvc is to be installed within or on external surface of an external wall above 11m in Scotland and above 18m in England and Wales, therefore, giving us no option but to design and manufacture a metal version.

# 4904



## Description

- ▶ Fixed Louvre Grille with 100mm circular spigot (male)
- ▶ Exhaust (air to outside)
- ▶ Intake (air from outside)

## Material

- ▶ HIPS (High Impact Polystyrene)

## Colour

- ▶ White (RAL9016)
- ▶ Brown (RAL8011)
- ▶ Terracotta (RAL8004)
- ▶ Cotswold (RAL1014)
- ▶ Grey (RAL7049)
- ▶ Black (RAL9017)

### Exhaust

Cubic equation to derive pressure drop  
 $= (-1.770 \times 10^{-5} V^3) + (0.0062 V^2) + (0.005 V) - 0.006$

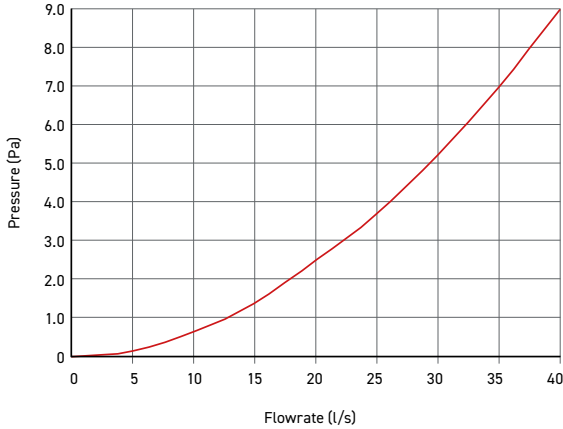

### Intake

Cubic equation to derive pressure drop  
 $= (-3.403 \times 10^{-5} V^3) + (0.0241 V^2) - (0.001 V) + 0.007$

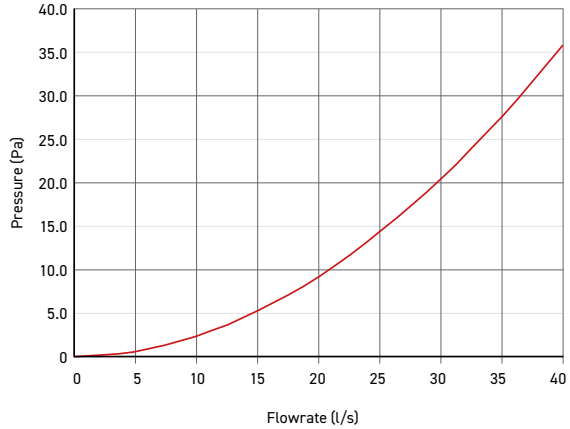

Performance data									
Airflow V' (l/s)	0	5	10	15	20	25	30	35	40
Pressure Drop (Pa)	0	0.2	0.7	1.4	2.5	3.7	5.2	6.9	9.0

Performance data									
Airflow V' (l/s)	0	5	10	15	20	25	30	35	40
Pressure Drop (Pa)	0	0.6	2.3	5.3	9.2	14.6	20.3	27.7	35.8

Performance data from BRE Test Report PR0393-1004:2015

Code	Description	Colour	Size (mm)	Connection
4904W	Rigid Duct Outlet Louvered Grille	White	H155xW155xD45	Male
4904G	Rigid Duct Outlet Louvered Grille	Grey	H155xW155xD45	Male
4904B	Rigid Duct Outlet Louvered Grille	Brown	H155xW155xD45	Male
4904C	Rigid Duct Outlet Louvered Grille	Cotswold	H155xW155xD45	Male
4904T	Rigid Duct Outlet Louvered Grille	Terracotta	H155xW155xD45	Male
4904BK	Rigid Duct Outlet Louvered Grille	Black	H155xW155xD45	Male
F4904W	Rigid Duct Outlet Louvered Grille with Flyscreen	White	H155xW155xD45	Male
F4904G	Rigid Duct Outlet Louvered Grille with Flyscreen	Grey	H155xW155xD45	Male
F4904B	Rigid Duct Outlet Louvered Grille with Flyscreen	Brown	H155xW155xD45	Male
F4904C	Rigid Duct Outlet Louvered Grille with Flyscreen	Cotswold	H155xW155xD45	Male
F4904T	Rigid Duct Outlet Louvered Grille with Flyscreen	Terracotta	H155xW155xD45	Male
F4904BK	Rigid Duct Outlet Louvered Grille with Flyscreen	Black	H155xW155xD45	Male

**Why metal external AirBricks?** This has been brought in owing to legislation changes, Part B fire regulations have recently changed and now confirm that no combustible material i.e. pvc is to be installed within or on external surface of an external wall above 11m in Scotland and above 18m in England and Wales, therefore, giving us no option but to design and manufacture a metal version.

# 5904



## Description

- ▶ Fixed Louvre Grille with 125mm circular spigot (male)
- ▶ Exhaust (air to outside)
- ▶ Intake (air from outside)

## Material

- ▶ HIPS (High Impact Polystyrene)

## Colour

- ▶ White (RAL9016)
- ▶ Brown (RAL8011)
- ▶ Terracotta (RAL8004)
- ▶ Cotswold (RAL1014)

### Exhaust

Cubic equation to derive pressure drop  
 $= (3.60510 - 6V^3) + (0.0012V^2) + (0.013V) - 0.032$

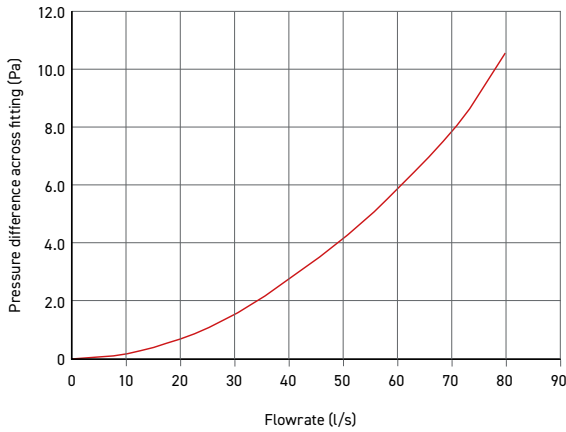

### Intake

Cubic equation to derive pressure drop  
 $= (1.63410 - 5V^3) + (0.0071V^2) + (0.046V) - 0.120$

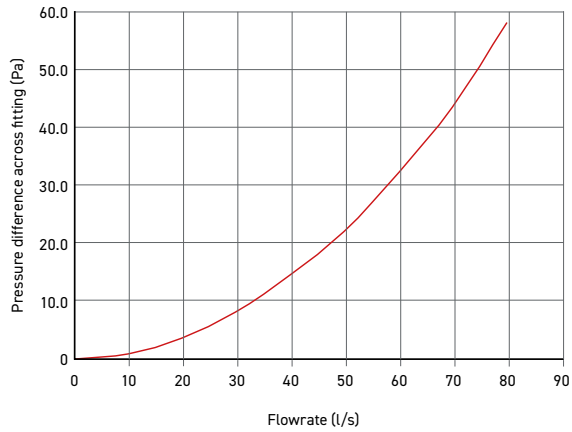

Performance data									
Airflow V (l/s)	0	10	20	30	40	50	60	70	80
Pressure Drop (Pa)	0	0.2	0.7	1.6	2.8	4.2	5.9	7.9	10.4

Performance data									
Airflow V (l/s)	0	10	20	30	40	50	60	70	80
Pressure Drop (Pa)	0	0.9	3.6	8.0	14.4	21.8	31.9	43.0	57.5

Performance data from BRE Test Report PR0393-1004:2015

	Code	Description	Colour	Size (mm)	Connection
	5904W	Rigid Duct Outlet Louvered Grille	White	H155xW155xD45	Male
	5904G	Rigid Duct Outlet Louvered Grille	Grey	H155xW155xD45	Male
	5904B	Rigid Duct Outlet Louvered Grille	Brown	H155xW155xD45	Male
	5904C	Rigid Duct Outlet Louvered Grille	Cotswold	H155xW155xD45	Male
	5904T	Rigid Duct Outlet Louvered Grille	Terracotta	H155xW155xD45	Male
	F5904W	Rigid Duct Outlet Louvered Grille with Flyscreen	White	H155xW155xD45	Male
	F5904G	Rigid Duct Outlet Louvered Grille with Flyscreen	Grey	H155xW155xD45	Male
	F5904B	Rigid Duct Outlet Louvered Grille with Flyscreen	Brown	H155xW155xD45	Male
	F5904C	Rigid Duct Outlet Louvered Grille with Flyscreen	Cotswold	H155xW155xD45	Male
	F5904T	Rigid Duct Outlet Louvered Grille with Flyscreen	Terracotta	H155xW155xD45	Male
	F5904BK	Rigid Duct Outlet Louvered Grille with Flyscreen	Black	H155xW155xD45	Male

**Why metal external AirBricks?** This has been brought in owing to legislation changes, Part B fire regulations have recently changed and now confirm that no combustible material i.e. pvc is to be installed within or on external surface of an external wall above 11m in Scotland and above 18m in England and Wales, therefore, giving us no option but to design and manufacture a metal version.



# 6904



## Description

- ▶ Fixed Louvre Grille with 150mm circular spigot (male)
- ▶ Exhaust (air to outside)
- ▶ Intake (air from outside)

## Material

- ▶ HIPS (High Impact Polystyrene)

## Colour

- ▶ White (RAL9016)
- ▶ Brown (RAL8011)
- ▶ Terracotta (RAL8004)
- ▶ Cotswold (RAL1014)

## Exhaust

Cubic equation to derive pressure drop  
 $= (-2.92110 - 6V^2) + (0.0015V^2) + (0.007V)$

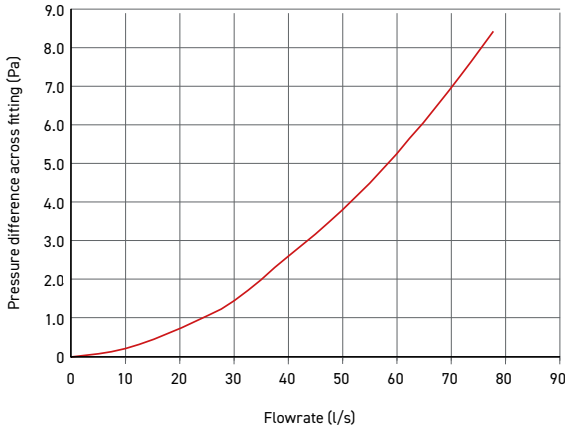

## Intake

Cubic equation to derive pressure drop  
 $= (5.18210 - 6V^2) + (0.0049V^2) + (0.013V) - 0.030$

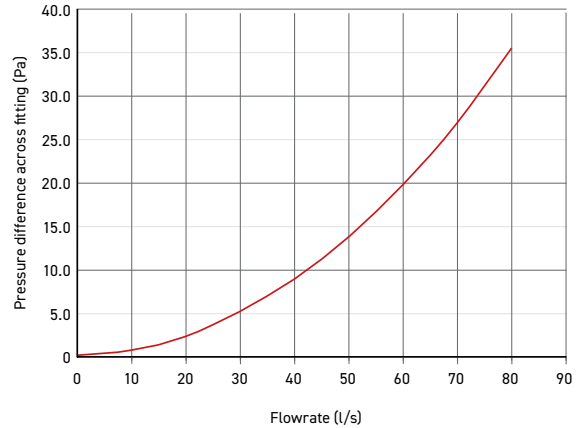

Performance data									
Airflow V (l/s)	0	10	20	30	40	50	60	70	80
Pressure Drop (Pa)	0	0.2	0.8	1.4	2.6	3.8	5.2	6.8	8.4

Performance data									
Airflow V (l/s)	0	10	20	30	40	50	60	70	80
Pressure Drop (Pa)	0	0.6	2.2	5.0	8.8	13.8	19.8	26.8	35.5

Performance data from BRE Test Report PR0393-1004:2015

	Code	Description	Colour	Size (mm)	Connection
	6904W	Rigid Duct Outlet Louvered Grille	White	H155xW155xD45	Male
	6904G	Rigid Duct Outlet Louvered Grille	Grey	H155xW155xD45	Male
	6904B	Rigid Duct Outlet Louvered Grille	Brown	H155xW155xD45	Male
	6904C	Rigid Duct Outlet Louvered Grille	Cotswold	H155xW155xD45	Male
	6904T	Rigid Duct Outlet Louvered Grille	Terracotta	H155xW155xD45	Male
	F6904W	Rigid Duct Outlet Louvered Grille with Flyscreen	White	H155xW155xD45	Male
	F6904G	Rigid Duct Outlet Louvered Grille with Flyscreen	Grey	H155xW155xD45	Male
	F6904B	Rigid Duct Outlet Louvered Grille with Flyscreen	Brown	H155xW155xD45	Male
	F6904C	Rigid Duct Outlet Louvered Grille with Flyscreen	Cotswold	H155xW155xD45	Male
	F6904T	Rigid Duct Outlet Louvered Grille with Flyscreen	Terracotta	H155xW155xD45	Male
	F6904BK	Rigid Duct Outlet Louvered Grille with Flyscreen	Black	H155xW155xD45	Male

**Why metal external AirBricks?** This has been brought in owing to legislation changes, Part B fire regulations have recently changed and now confirm that no combustible material i.e. pvc is to be installed within or on external surface of an external wall above 11m in Scotland and above 18m in England and Wales, therefore, giving us no option but to design and manufacture a metal version.

# ART125-DT1S



## Description

- ▶ Architectural Grille with 125mm circular spigot (male)
- ▶ Extract (air from rooms)
- ▶ Supply (air to rooms)

## Material

- ▶ HIPS (High Impact Polystyrene)

## Colour

- ▶ Silver

### Exhaust

Cubic equation to derive pressure drop  
 $= 0.0055x^2 + 0.0371x - 0.1038$

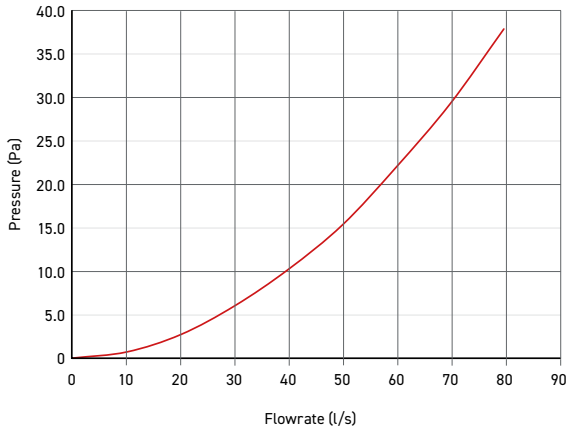

### Intake

Cubic equation to derive pressure drop  
 $= 0.0125x^2 - 0.008x - 0.0354$

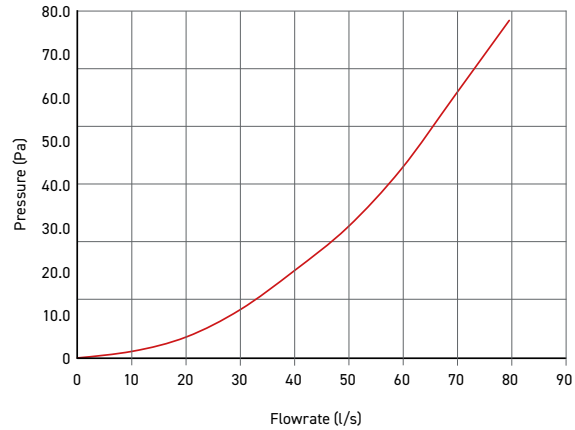

Performance data									
Airflow V' (l/s)	0	10	20	30	40	50	60	70	80
Pressure Drop (Pa)	0	0.7	2.7	6.0	10.2	15.3	21.9	29.2	37.8

Performance data									
Airflow V' (l/s)	0	10	20	30	40	50	60	70	80
Pressure Drop (Pa)	0	1.2	4.6	11.0	20.1	30.4	44.2	61.6	79.2



Performance data from Test Report TR1622

Code	Description	Colour	Size (mm)	Connection
ART125-CF1S	Architectural Room Terminal Curved	Silver	H202xW208xD100	N/A
ART125-CF1BM	Architectural Room Terminal Curved	Brushed Metal	H202xW208xD100	N/A
ART125-CF1W	Architectural Room Terminal Curved	White	H202xW208xD100	N/A
ART125-DT1S	Architectural Room Terminal Circular Indent	Silver	H200xW200xD88	N/A
ART125-DT1W	Architectural Room Terminal Circular Indent	White	H200xW200xD88	N/A
ART125-SD2W	Architectural Diffuser Wave	White	H188xW188xD30	N/A
ART125-SD1W	Architectural Diffuser	White	H188xW188xD30	N/A
ART125-CD1W	Architectural Circular Diffuser	White	H176xW176xD68	N/A





**Why metal external AirBricks?** This has been brought in owing to legislation changes, Part B fire regulations have recently changed and now confirm that no combustible material i.e. pvc is to be installed within or on external surface of an external wall above 11m in Scotland and above 18m in England and Wales, therefore, giving us no option but to design and manufacture a metal version.

# INTERNAL DUCT TERMINALS





## Ø100mm System

	Code	Description	Colour	Size (mm)	Connection
	136-04	Air Valve Extract or Supply	White	H147xW147xD43	Male
	136-24	Air Valve Extract or Supply Suspended Ceiling	White	H147xW147xD75	Male
	136FR-24M	Air Valve Extract or Supply Suspended Ceiling (Fire Rated)	White	H200xW200xD88	Male
	4908F	Multi-Directional Diffuser with Filter	White	H154xW154xD64	Male
	40AF	Environmental Filter Spare Part	Grey	N/A	N/A
	40AFP	Pollen Filter Spare Part	Grey	N/A	N/A
	4907W	Rigid Duct Diffuser	White	H140xW140xD70	Male
	4907CH	Rigid Duct Diffuser	Chrome	H140xW140xD70	Male

## Ø125mm System

	Code	Description	Colour	Size (mm)	Connection
	136-05	Air Valve Extract or Supply	White	H165xW165xD40	Male
	136-25	Air Valve Extract or Supply Suspended Ceiling	White	H165xW165xD78	Male
	136FR-25M	Air Valve Extract or Supply Suspended Ceiling (Fire Rated)	White	H166xW166xD58	Male
	5907W	Rigid Duct Diffuser	White	H165xW165xD71	Male

**Ø150mm System**

	<b>Code</b>	<b>Description</b>	<b>Colour</b>	<b>Size (mm)</b>	<b>Connection</b>
	136-06	Air Valve Extract or Supply	White	H183xW183xD40	Male
	136-26	Air Valve Extract or Supply Suspended Ceiling	White	H199xW199xD76.5	Male
	136FR-26M	Air Valve Extract or Supply Suspended Ceiling (Fire Rated)	White	H199W199D58	Male
	6907W	Rigid Duct Diffuser	White	H186xW186xD70	Male

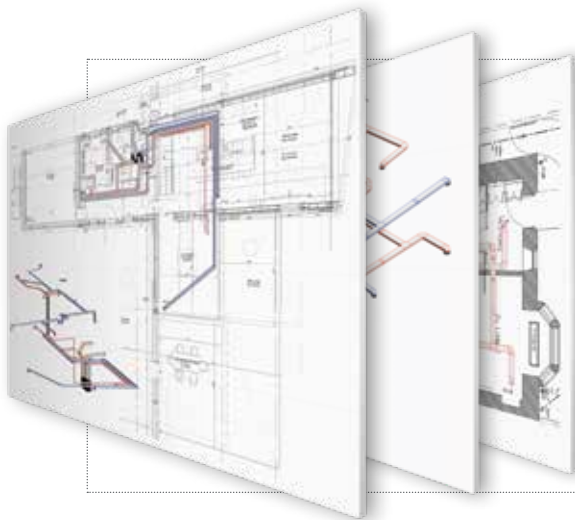

**SEND US YOUR PROJECT DETAILS AND RECEIVE:**

- ▶ An assigned estimator/designer who will become your direct point of contact
- ▶ **FREE OF CHARGE** drawings available in AutoCAD or Revit
- ▶ A full BOM (bill of materials)
- ▶ Scheduled, nation-wide delivery
- ▶ Ongoing technical support when our product is on site

## ► FLEXIBLE DUCTING

Domus Ventilation flexible is available in all standard UK round and rectangular sizes. The range includes Hose, Insulated Hose and Aluminium Hose.

### Round PVC Flexible Hose – 1m – 45m



Ø100mm EasyPipe 100
<p>Free Area 7,850mm<sup>2</sup></p>

Ø125mm EasyPipe 125
<p>Free Area 12,266mm<sup>2</sup></p>

Ø150mm EasyPipe 150
<p>Free Area 17,263mm<sup>2</sup></p>

### Overview

Domus Ventilation Flexible Hose is a range of wire reinforced, flexible PVC ducting that has been specially designed for the ventilation market. The round profiles are compatible with the Domus Ventilation rigid PVC product range.

The hose provides solutions to overcome situations where a rigid component cannot be installed. Flexible hose is particularly suitable for installation where there is slow moving air.

### Construction

The Flexible Hose is constructed as a continuous helix on a bespoke forming 'head'. The reinforcing wire is 100% sealed inside a fold of PVC tape which is in turn overlapped by the next pitch. The joints are welded by hot air welding of the layers of PVC in order to produce a continuous sealed tube.

Code	Connection
<b>Hose – 1m</b>	
361	Female
<b>Hose – 3m</b>	
363	Female
<b>Hose – 6m</b>	
366	Female
<b>Hose – 15m</b>	
3615	Female
<b>Hose – 45m</b>	
3645	Female

Code	Connection
<b>Hose – 1m</b>	
561	Female
<b>Hose – 3m</b>	
563	Female
<b>Hose – 6m</b>	
566	Female
<b>Hose – 15m</b>	
5615	Female
<b>Hose – 45m</b>	
N/A	N/A

Code	Connection
<b>Hose – 1m</b>	
661	Female
<b>Hose – 3m</b>	
663	Female
<b>Hose – 6m</b>	
666	Female
<b>Hose – 15m</b>	
6615	Female
<b>Hose – 45m</b>	
N/A	N/A

### Technical data

Material	White PVC 70µm thick
Diameter range (mm) (internal)	100, 125, 150
Temperature range (°C)	-20/+60 working (80 max.)
Maximum air velocity	30 m/sec
Max. positive working pressure	3000 Pa
Standard length	1, 3, 6, 15, 45 metres (45m in 100mm only)
Packing	Compressed individually in net sleeve
Clamping	Domus Adjustable Round Hose Clip 100mm – 125-4 125mm – 125-5 150mm – 125-6

Aluminium/Polyester Flexible Hose – 3m - 10m



Ø100mm  
EasyPipe 100



Free Area 7,850mm<sup>2</sup>

Ø125mm  
EasyPipe 125



Free Area 12,266mm<sup>2</sup>

Ø150mm  
EasyPipe 150



Free Area 17,263mm<sup>2</sup>

Overview

The Aluminium Flexible Hose is a range of fully flexible uninsulated aluminium/polyester laminated ducting, which has been specially designed for Domus Ventilation. Owing to its flexibility it is easy to connect to either round or oval ducting.

Code	Connection
Hose – 3m	
3133	Female
Hose – 6m	
3136	Female
Hose – 10m	
31310	Female

Code	Connection
Hose – 3m	
5133	Female
Hose – 6m	
5136	Female
Hose – 10m	
51310	Female

Code	Connection
Hose – 3m	
6133	Female
Hose – 6m	
6136	Female
Hose – 10m	
N/A	N/A

Key benefits

- ▶ Supplied in standard 10 metre length, compressed to 0.6 metre.
- ▶ Individually boxed.
- ▶ Easy to connect to either round or oval ducting.
- ▶ No special tools required for cutting or fixing.
- ▶ In the event of a fire, no toxic gases are emitted.
- ▶ The products have been successfully fire resistance tested to BS476 parts 6, 7 and 20.

Technical data

Construction material	Reinforced Aluminium/Polyester
Wirepitch	24mm
Diameter range (mm)	100 / 125 / 150
Temperature range (°C)	-30/+140
Maximum air velocity	30m/sec
Max. positive working pressure	2500 Pa
Standard length	10 metre
Packing	Individual box of 0.6 metre
Clamping	Lightning Band, Stainless Steel Clamps, Nylon Clamps or Quick Release Clamps

Construction

The Domus Ventilation Aluminium Flexible Hose is multi-ply reinforced aluminium and polyester laminated ducting with an encapsulated high tensile steel wire helix.

Aluminium Insulated Flexible Hose – 10m



Ø100mm  
EasyPipe 100



Free Area 7,850mm<sup>2</sup>

Ø125mm  
EasyPipe 125



Free Area 12,266mm<sup>2</sup>

Ø150mm  
EasyPipe 150



Free Area 17,263mm<sup>2</sup>

**Overview**

Domus Ventilation Insulated Flexible Hose is a range of fully thermally insulated ducting, which has been specially designed for the ventilation market. It has been developed to minimise heat gain or loss resulting from the temperature differential between the airflow and the surrounding ambient air. The vapour barrier prevents condensation from forming on the outside of ducts carrying air at lower temperatures than the surrounding air.

**Key benefits**

- ▶ Supplied in standard 10 metre length, compressed to 1 metre.
- ▶ Individually boxed.
- ▶ Easy to connect to either round or oval ducting.
- ▶ No special tools required for cutting or fixing.
- ▶ In the event of a fire, no toxic gases are emitted.
- ▶ The products have been successfully tested for fire resistance and conform to BS476 Parts 6 and 7.

Code	Connection
Hose – 10m	
4210	Female

Code	Connection
Hose – 10m	
5210	Female

Code	Connection
Hose – 10m	
6210	Female

**Technical data**

Insulation	16kg/m <sup>3</sup> Glass wool, 25mm thickness
Diameter range (mm) (internal)	100, 125, 150
Temperature range (°C)	-30/+150
Maximum air velocity	30 m/sec
Max. positive working pressure	3000 Pa
Standard length	10 metre
Packing	Individual box compressed to 1m
Clamping	Domus Ventilation Adjustable Round Hose Clip 100mm – 125-4 125mm – 125-5 150mm – 125-6

**Construction**

Domus Ventilation Insulated Flexible is produced from multi-layer aluminium and metallised polyester, strengthened with high tension hard steel spring wire, surrounded with glass wool insulation and an aluminium vapour barrier.

Aluminium Flexible Duct – 0.3m - 3m



Ø100mm  
EasyPipe 100



Free Area 7,850mm<sup>2</sup>

Ø125mm  
EasyPipe 125



Free Area 12,266mm<sup>2</sup>

Ø150mm  
EasyPipe 150



Free Area 17,263mm<sup>2</sup>

Overview

For years the designer's need for a fire resistant flexible duct has been hampered by the lack of flexibility and fragile nature of metallic ducting. Now, Domus Ventilation Aluminium Flexible Duct overcome these problems.

Aluminium Flexible Duct is a corrugated flexible ducting, which can be formed to bend radius less than ½D. It is supplied in its compressed state, but when installed the tube extends to 4 metres for maximum flexibility and economy – making it the simple answer to many flexible duct problems.

Key benefits

- ▶ Constant cross section for predictable air flow characteristics.
- ▶ Reduced need for supports on longer duct runs.
- ▶ Fire resistant to BS 476 Part 8 with negligible smoke generation.
- ▶ Extra flexibility. Ideal for short final connections.
- ▶ Supplied in compressed lengths and individually boxed for site protection, easy handling and storage.

Code	Connection
<b>Hose – 0.3m</b>	
403203	Female
<b>Hose – 1.5m</b>	
403215	Female
<b>Hose – 3m</b>	
403230	Female

Flexible

It is available in 100mm, 125mm and 150mm diameter and may be hand-formed to bends of less than a 1/2D Radius- a feature previously only thought possible with fabric flexibles.

Aluminium Flexible Duct can also be extended or compressed easily for installation between spigots located opposite to each other. It is ideal for final connections or where space is limited.

Strong

Strength and pliability in metal flexibles are affected by the thickness, corrugation shape and ductility of the material used in construction. In the past a strong tube has lacked flexibility and flexible tube has lacked strength.

Code	Connection
<b>Hose – 0.3m</b>	
503203	Female
<b>Hose – 1.5m</b>	
503215	Female
<b>Hose – 3m</b>	
503230	Female

With Aluminium Flexible Duct the problems are overcome by producing a deep corrugation tube, which is kept in the compressed state until it is installed; in this state it has great strength with little flexibility. At the time of installation, when strength is a lower priority, the tube is extended to achieve its ultimate in flexibility.

Self supporting

Aluminium Flexible Duct retains its corrugation form in use and, in doing so, achieves maximum distance between supports without sagging, resulting in cost savings in labour and materials when compared to fabric flexible.

It also retains its cross section regardless of its state; it can be compressed, extended, or formed into bends or offsets with no reduction in area.

Code	Connection
<b>Hose – 0.3m</b>	
603203	Female
<b>Hose – 1.5m</b>	
603215	Female
<b>Hose – 3m</b>	
603230	Female

This means that frictional resistance figures are constant and air flow figures can be accurately predicted at the design stage.

The tube is stable after forming with no tendency to spring back, thus forces on spigots are kept to the very minimum.

Fire resisting

Aluminium Flexible Duct is tested to BS476 Part 6, 7 and 8, and meets the requirements for CP413 section A2.2.3 (Ducts for Building Services) and is suitable for use throughout the U.K. and the Continent. When tested to BS476 Part 7 a class 1 spread of flame was recorded. When tested under the conditions laid down in BS476 Part 8 Aluminium Flexible Duct maintained its integrity for 15 minutes. As it is of all metal construction smoke generation is negligible.



**Aluminium Hose Clip – 100, 125 and 150mm (for installation with Domus Flexible Hose)**



**Overview**

The Aluminium Duct Clips are designed to provide a secure, air-tight connection. The range also includes Universal Connectors, offering greater installation flexibility.

**Ø100mm  
EasyPipe 100**

**Free Area 7,850mm<sup>2</sup>**

Code	Connection
125-4	90-110mm

**Ø125mm  
EasyPipe 125**

**Free Area 12,266mm<sup>2</sup>**

Code	Connection
125-5	110-130mm

**Ø150mm  
EasyPipe 150**

**Free Area 17,263mm<sup>2</sup>**

Code	Connection
125-6	140-160mm

**Aluminium Universal Hose Clip – 100, 125 and 150mm (for installation with Domus Flexible Hose)**



**Overview**

The Aluminium Duct Clips are designed to provide a secure, air-tight connection. The range also includes Universal Connectors, offering greater installation flexibility.

**Ø100mm  
EasyPipe 100**

**Free Area 7,850mm<sup>2</sup>**

Code	Connection
125-UNI	90-110mm

**Ø125mm  
EasyPipe 125**

**Free Area 12,266mm<sup>2</sup>**

Code	Connection
125-UNI	110-130mm

**Ø150mm  
EasyPipe 150**

**Free Area 17,263mm<sup>2</sup>**

Code	Connection
125-UNI	140-160mm

## ROUND FLEXIBLE HOSE CONNECTORS

Our flexible hose connectors are designed to achieve the highest possible energy efficiency from our ventilation appliances.

They are manufactured from exacting tolerances to virtually eliminate air leakage and reduce pressure drop.

Ø100mm  
EasyPipe 100



Free Area 7,850mm<sup>2</sup>

Ø125mm  
EasyPipe 125



Free Area 12,266mm<sup>2</sup>

Ø150mm  
EasyPipe 150



Free Area 17,263mm<sup>2</sup>

### Round Flexible Hose Connectors – 0.1m



Code	Connection
Hose – 0.1m	
380	Male

Code	Connection
Hose – 0.1m	
580	Male

Code	Connection
Hose – 0.1m	
680	Male

### Round Flexible Hose Connectors – With Threaded Socket



Code	Connection
126-4	Female

Code	Connection
126-5	Female

Code	Connection
126-6	Female

### Round Flexible Hose Connectors – With Threaded Spigot



Code	Connection
124-4	Male

Code	Connection
N/A	N/A

Code	Connection
N/A	N/A

**Rectangular Flexible PVC Hose – 0.5m - 3m**



**Overview**

Domus Ventilation Flexible Hose is a range of wire reinforced, flexible PVC ducting that has been specially designed for the ventilation market.

The hose provides solutions to overcome situations where a rigid component cannot be installed.

Flexible Hose is particularly suitable for installation where there is slow moving air.

**110x54mm System**



Code	Connection
<b>Hose – 0.5m</b>	
3305	Female
<b>Hose – 3m</b>	
333	Female

**204x60mm System**

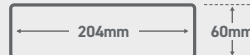

Code	Connection
<b>Hose – 0.5m</b>	
5305	Female
<b>Hose – 3m</b>	
533	Female

**220x90mm System**

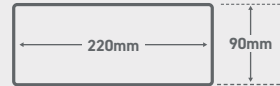

Code	Connection
<b>Hose – 0.5m</b>	
9305	Female
<b>Hose – 3m</b>	
933	Female

**Construction**

The Flexible Hose is constructed as a continuous helix on a bespoke forming 'head'. The reinforcing wire is 100% sealed inside a fold of PVC tape which is in turn overlapped by the next pitch. The joints are welded by hot air welding of the layers of PVC, in order to produce a continuous sealed tube.

**Technical data**

Material	White PVC 70µm thick
Sizes mm (internal)	110x54, 204x60, 220x90
Temperature range (°C)	-20/+60 working (80 max.)
Standard length (m)	0.5, 3
Packing	Compressed individually in net sleeve
Clamping	D-TIE Nylon zip-tie

**Rectangular Flexible Hose Connectors – 0.1m and 0.14m**



Designed to achieve the highest possible energy efficiency from our ventilation appliances.

**110x54mm System**



Code	Connection
<b>Length – 0.1m</b>	
381	Duct

**204x60mm System**

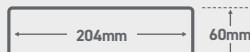

Code	Connection
<b>Length – 0.1m</b>	
581	Duct

**220x90mm System**



Code	Connection
<b>Length – 0.14m</b>	
981	Duct

## ▶ DUCTING ANCILLARIES

Alongside our ventilation systems and ducting, we offer a range of ancillary items.

### Rigid Duct Aluminium Duct Tape – 45m & 100m



Code	Length
50TP45	45m
50TP100	100m

#### Overview

A 30 Micron soft tempered bright aluminium foil. Coated with high tack pressure adhesive which has excellent UV light resistance on a white glassine liner.

This product is recommended where a moisture barrier and cold weather performance is required.

Technical data	Typical values
Adhesive colour:	Clear
Adhesive type:	Acrylic UV Light resistance
Tape thickness:	0.060mm (without liner)
Foil thickness:	0.030mm
Peel adhesion to steel:	1000N/m
Loop tack:	800N/m
Shear (static):	87 Hours @ 1kg
Fire protection:	Conforms to Class 0 BS476 part 7 & 6 1987
Minimum applic temp:	0°C
Service range:	-20°C to 120°C
Shelf life:	12 months (PSMA Conditions)

### 40123 Prepack PVC Duct Tape – 50mm x 10m



Code	Length
123-10	4.6m
123	33m

#### Applications

- ▶ Jointing of polythene sheeting
- ▶ Barrier tape to prevent electrolytic reaction
- ▶ Sealing insulation panels
- ▶ Patching, sealing (boxes, drums, kegs) repair

Technical data	Typical values
Total thickness:	0.14 mm
Adhesive power:	200N/m
Backing thickness:	-
Tensile strength:	2KN/m
Elongation:	200%
Temperature:	-20°C to 80°C
Dielectric strength:	6KV
Colours:	Black, White, Grey
Shelf life:	12 months

## Rigid Duct Intumescent Sealant – available in 310ml size



Code

DDSEAL

## Key features

- ▶ Good adhesion to timber, plasterboard, masonry, blockwork, plaster, concrete and many other common building surfaces.
- ▶ Up to four hours fire resistance.
- ▶ Over-paintable with solvent and water based paints.
- ▶ Suitable for horizontal and vertical joints without compromising fire rating performance.

- ▶ For use in joints up to 50mm.
- ▶ Water based, solvent and halogen free, water clean up.
- ▶ Reduces sound transmission in joints.
- ▶ Formulated using a special acrylic emulsion to provide a firm seal whilst retaining a degree of flexibility.
- ▶ Joint movement capability of  $\pm 12.5\%$ .
- ▶ Will not support combustion.
- ▶ Colour: white.

## Description

DDSEAL sealant is a waterborne one-part fire-resistant and acoustic rated joint sealant which provides a firm, yet flexible, seal to joints in a wide variety of fire-rated structures where fire resistance up to four hours is required. Its special intumescent properties cause the sealant to swell up and char in the presence of heat, preventing the spread of smoke and fire through the joint.

## Technical approvals

DDSEAL conforms to the following standards:

## Fire Performance

BS 476:Part 20:1987.

BS EN 13666-3 with additional guidelines from BS EN 1366-4

## Acoustic Performance:

Tested in accordance with BS EN ISO 140-3:1995

## Sealant Classification ISO 11600 Classification:

F-12.5-P

## Uses

- ▶ Sealing joints, voids and irregular holes where fire resistance up to four hours is required.
- ▶ Ideal for sealing joints, voids and irregular holes in fire walls, partitions, door architraves, service penetrations, floors and other structures.
- ▶ For bedding of hinges and locks in fire doors.
- ▶ For perimeter sealing of internal, fire rated screens, partitions, service penetrations and door or window frames.
- ▶ To maintain integrity when sealing around pipes, services and cable.
- ▶ Sealing fire rated ductwork.

## Rigid Duct Acrylic Sealant – available in 310ml size



Code

DASEAL

## Key features

- ▶ Good adhesion to a wide variety of surfaces including PVC, timber and brickwork.
- ▶ Easy to apply and finish.
- ▶ Can be overpainted within one-two hours with both water and solvent borne paints.
- ▶ Quick drying – forms a skin within 15 minutes internally.
- ▶ Contains a high level of fungicide for long term decorative appearance.
- ▶ Colours: Brown & white.

## Description

DASEAL is a high performance emulsion acrylic sealant based on the latest developments in acrylic elastomer technology. It has been specially formulated for sealing around window frames, skirtings, architraves and general small gap filling.

It offers a degree of flexibility whilst still retaining the ability to be easily overcoated with conventional paints. Although primarily used internally, it has good external performance when applied in suitable conditions.

## Uses

- ▶ For sealing internal joints around window and door frames, skirting boards, coving and dado rails.
- ▶ Sealing cracks in plaster.
- ▶ Perimeter pointing of windows and doors.
- ▶ External low to medium movement joints between brick, concrete and timber.

Note: Ensure that the conditions are suitable to allow the development of a substantial skin before exposure to rain, typically a minimum of four hours.

## Technical approvals

DASEAL is a high performance sealant which conforms to ISO 11600 - F-12.5P.

**YOUR  
VENTILATION  
SPECIALIST**

**03443 715 523**

[www.domusventilation.co.uk](http://www.domusventilation.co.uk)



**Domus Ventilation**  
Western Industrial Estate  
Caerphilly  
CF83 1NA